

# Automotive 66201 SERIES



5.0 PITCH POWER CONNECTOR

RoHS REACH LF HFA

## 66201S Plug Housing

### Specifications

- ◇ Current rating: 20A DC/AC (with 2.5mm<sup>2</sup> wire)
- ◇ Voltage Range: 24V AC,DC
- ◇ Withstand Voltage: 1000V AC/Minute
- ◇ Insulation Resistance: 1000 MΩ Min.
- ◇ Contact Resistance: 6 mΩ Max. before environment test
- ◇ Temperature Range: -30°C to 125°C
- ◇ Wire Range: 0.8 mm<sup>2</sup> to 2.5 mm<sup>2</sup> (AWG 12 – 18)

### Reference

- ◇ Use with 66201T Pin-Contact Terminal
- ◇ Mates with 66202S Receptacle Housing

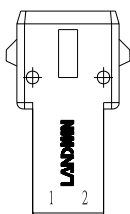
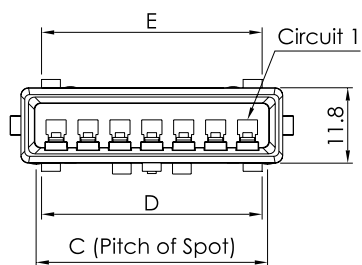
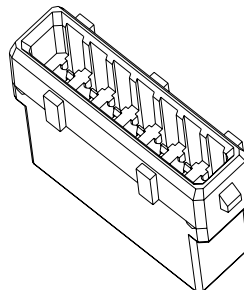

2PIN

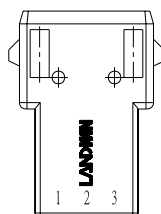

3PIN

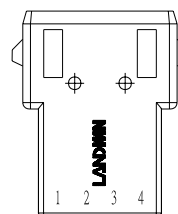

4PIN

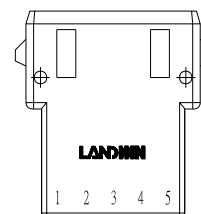

5PIN

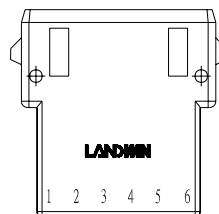
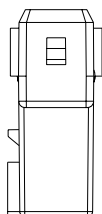
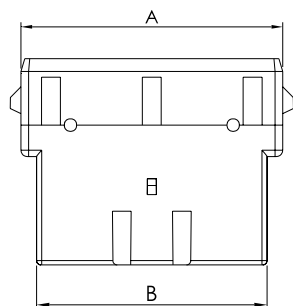

6PIN

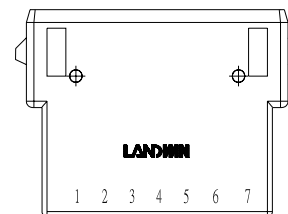

7PIN

### Ordering Information

Circuits	Part No.	Dimension				
		A	B	C	D	E
2	66201S0203	16.8	12.3	12.2	-----	-----
3	66201S0303	21.4	16.3	16.4	-----	17.9
4	66201S0403	26.4	21.2	17.8	13.8	18.0
5	66201S0503	31.5	26.2	18.4	27.2	17.7
6	66201S0603	36.2	31.3	23.6	32.4	22.9
7	66201S0703	41.6	36.3	25.6	34.9	22.9

### Material

Part	Material
Housing	Glass-Filled PBT, UL 94V-0, Black

※ Available P/N of Halogen-Free replacement:  
66201S xx 03-BNH ( xx : Circuit No.)

# Automotive 66202 SERIES



## 5.0 PITCH POWER CONNECTOR

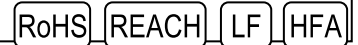

### 66202S Receptacle Housing With Cable Holder

#### Specifications

- ◇ Current rating: 20A DC/AC (with 2.5mm<sup>2</sup> wire)
- ◇ Voltage Range: 24V AC,DC
- ◇ Withstand Voltage: 1000V AC/Minute
- ◇ Insulation Resistance: 1000 M $\Omega$  Min.
- ◇ Contact Resistance: 6 m $\Omega$  Max. before environment test
- ◇ Temperature Range: -30 $^{\circ}$ C to 125 $^{\circ}$ C
- ◇ Wire Range: 0.8 mm<sup>2</sup> to 2.5 mm<sup>2</sup> (AWG 12 – 18)

#### Reference

- ◇ Use with 66202T Terminal
- ◇ Mates with 66201S Plug Housing

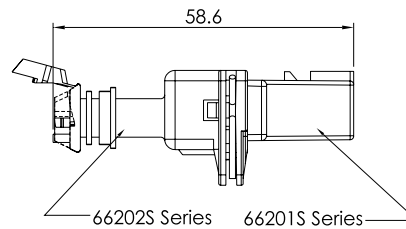
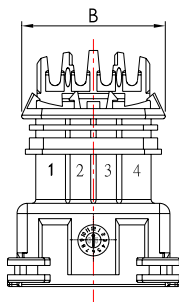
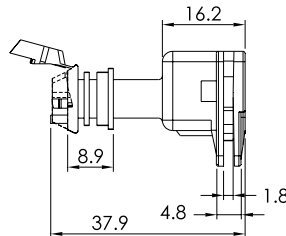
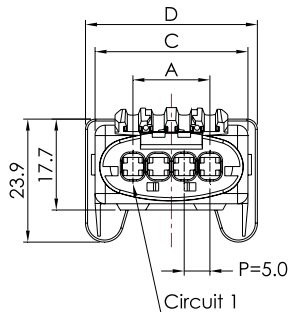
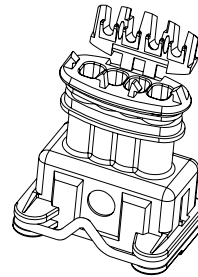

Assembly Layout

#### Ordering Information

Circuits	Part No.	Dimension			
		A	B	C	D
2	66202S0203	5.0	18.2	19.8	23.5
3	66202S0303	10.0	23.2	24.8	28.5
4	66202S0403	15.0	28.2	29.8	33.5
5	66202S0503	20.0	33.2	34.8	38.5
6	66202S0603	25.0	38.2	39.8	43.5
7	66202S0703	30.0	43.2	44.8	48.5

#### Material

Part	Material
Housing	NYLON 66 94V-0, Black
Clip	Stainless Steel

※ Available P/N of Halogen-Free replacement:  
66202S xx 03-BNH ( xx : Circuit No.)

# Automotive 66202 SERIES



**5.0 PITCH** POWER CONNECTOR

RoHS REACH LF HFA

## 66202S Receptacle Housing

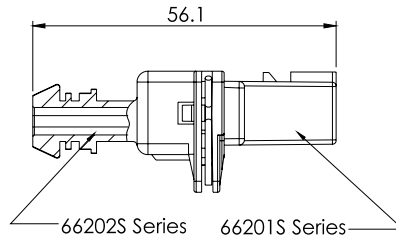
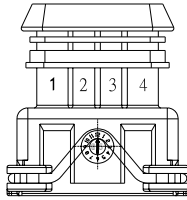
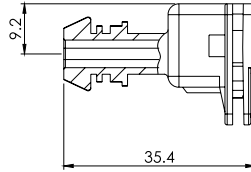
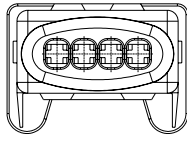

66202SXX13

Assembly Layout

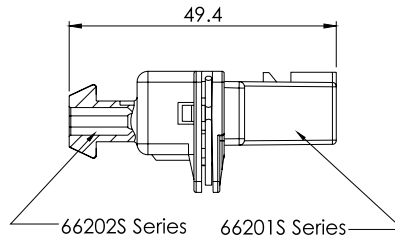
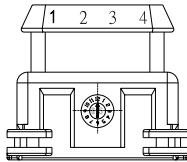
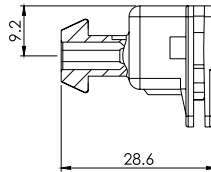
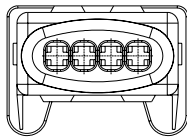

66202SXX23 (Low-Profile)

Assembly Layout

### Ordering Information

Circuits	Part No.		Dimension			
	W/O Cover	Low-Profile	A	B	C	D
2	66202S0213	66202S0223	5.0	18.2	19.8	23.5
3	66202S0313	66202S0323	10.0	23.2	24.8	28.5
4	66202S0413	66202S0423	15.0	28.2	29.8	33.5
5	66202S0513	66202S0523	20.0	33.2	34.8	38.5
6	66202S0613	66202S0623	25.0	38.2	39.8	43.5
7	66202S0713	66202S0723	30.0	43.2	44.8	48.5

### Material

Part	Material	Remark
Housing	Glass-Filled PBT, UL 94V-0, Black	
Clip	Stainless Steel	

※ Available P/N of Halogen-Free replacement:

66202S xx 13-BNH ( xx : Circuit No.)

66202S xx 23-BNH ( xx : Circuit No.)

# Automotive 66201 SERIES



## 5.0 PITCH POWER CONNECTOR



### 66201T PIN-Contact Terminal

- Reference
- ◇ Mates with 66202T Terminal
- ◇ Use with 66201S Plug Housing

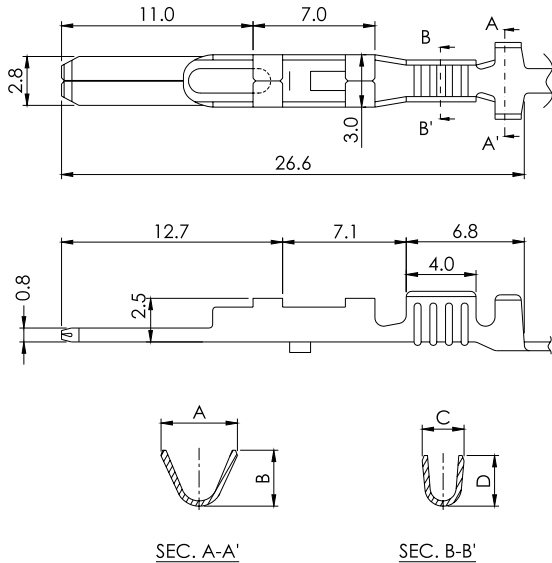
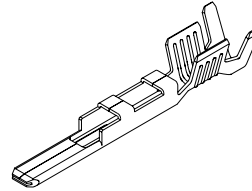

#### Ordering Information

Part Number	Applicable Wire		Q'ty / Reel
	AWG #	Insulation O.D. mm	
66201T012R	22 - 16	2.2 Max.	10,000
66201T022R	16 - 12	3.3 Max.	10,000

#### Material

Part No.	Material / Plating	Dimension			
		A	B	C	D
66201T012R	Brass	4.4	3.2	2.4	2.9
66201T022R	Tin-Plated	6.0	5.4	4.1	4.4

※ Halogen-Free Product

### 66202T Receptacle Contact Terminal

- Reference
- ◇ Mates with 66201T Terminal
- ◇ Mates with 66202S Receptacle Housing

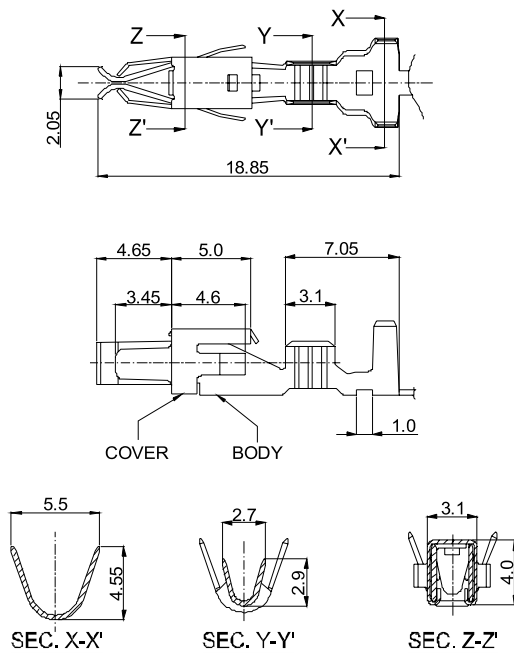
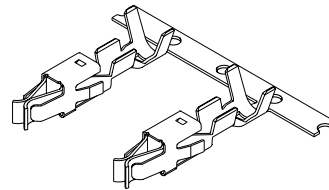

#### Ordering Information

Part Number	Applicable Wire		Q'ty / Reel
	AWG #	Insulation O.D. mm	
66202T121R	14 - 18	3.3 Max.	3,000

#### Material

Part No.	Material
66202T121R	Body: Phosphor Bronze, Tin-Plated Cover: Stainless

※ Halogen-Free Product