

# Rectangular Connectors

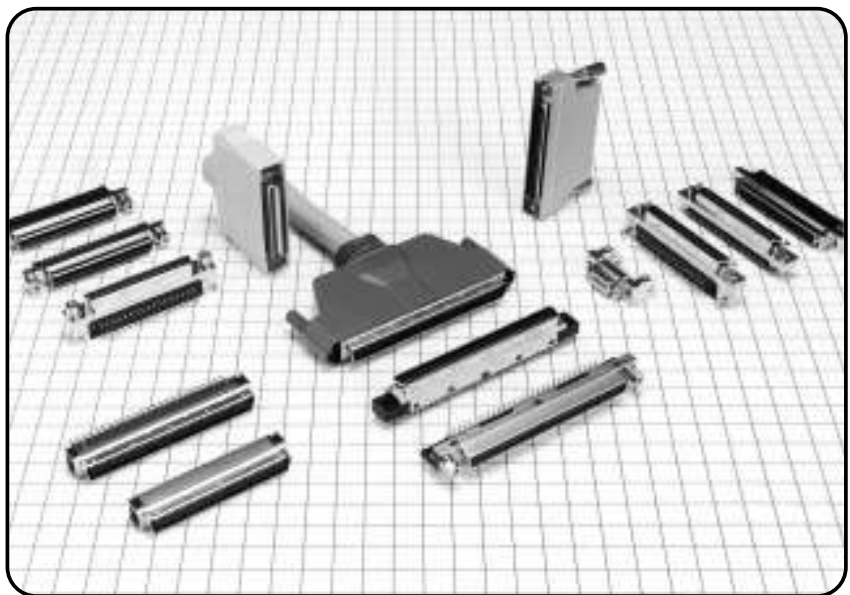

# Rectangular Connectors

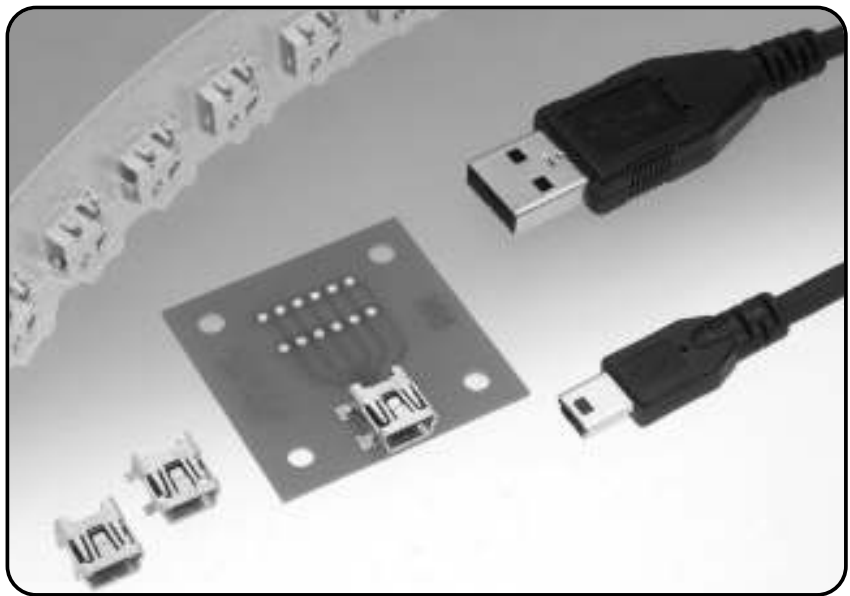

## Subminiature Interface Connectors

| Type   | Series Name | Page |
|--|-------------|------|
| Connectors compliant to USB 2.0 standard                                       | UX          | 33   |
| Interface connectors for miniature, portable terminal devices                  | ST          | 33   |
| Interface connectors for mobile phone  | MQ138       | 34   |
| 20,000 times of mating cycle, interface connectors for portable equipment      | 3500        | 34   |
| 0.8mm pitch, SMT ultra small interface connectors                              | 3200        | 35   |
| 1.27mm pitch interface connectors for electrostatic discharge (ESD) protection | 3100        | 35   |
| 1.78mm pitch connectors for hand-held terminals                                | QM          | 36   |

## Interface connectors for AC power supply

| Type   | Series Name | Page |
|--|-------------|------|
| Micro-miniature interface connectors for AC power supply/signaling | MQ172       | 36   |

## Docking station connectors

| Type                                    | Series Name | Page |
|---|-------------|------|
| 0.6mm pitch, docking station connectors | EX80        | 37   |

## Interface Connectors

| Type  | Series Name | Page |
|---|-------------|------|
| High-speed differential signal connectors                     | EXT         | 37   |
| D-configuration connectors for digital broadcasting equipment | DX*LM       | 38   |
| Connectors compliant to ANSI SCSI standard                    | DX*M        | 38   |
| 1.27mm pitch IDC connectors                                   | DX          | 39   |
| Ribbon contact connectors                                     | RC          | 39   |
| 2.54mm pitch crimp/IDC connectors                             | DN          | 40   |

## D-sub Connectors

| Type  | Series Name | Page |
|---|-------------|------|
| D-sub right angle receptacle                                  | RD*D        | 40   |
| D-sub space saving type receptacle                            | RD*G        | 41   |
| D-sub receptacle with a built-in ferrite core                 | RD*F        | 41   |
| D-sub right angle receptacle                                  | RD*B        | 42   |
| D-sub straight through hole type connectors                   | SD          | 42   |
| D-sub solder type connectors                                  | HD          | 43   |
| D-sub connectors, IDC termination                             | FD*D        | 43   |
| D-sub connectors, IDC termination                             | FD          | 44   |
| D-sub crimp type connectors                                   | CD          | 44   |
| D-sub connectors with coaxial contact                         | JDM         | 45   |
| D-sub cover for electromagnetic interference (EMI) protection | CTH         | 45   |
| D-sub plastic cover   | CTF         | 46   |

## High-current Connectors

| Type                    | Current rating  | Series Name | Page |
|-------------------------|-----------------|-------------|------|
| High-current connectors | 2.5A, 50A, 200A | PS          | 46   |

## Multi-positions Standard type Connectors

| Type                             | Current rating | Series Name | Page |
|----------------------------------|----------------|-------------|------|
| Hirose Unique Samicon connectors | 3A             | 1600        | 47   |
| Hirose Unique Minicon connectors | 5A             | 1300        | 47   |

## Power Connectors for Industrial equipments, Business machines

| Type   | Current rating | Series Name | Page |
|--|----------------|-------------|------|
| Power supply connectors for industrial equipment | 10A            | PX          | 48   |
| Rack/panel crimp connectors (13A max.)           | 13A            | QR/P        | 48   |
| Rack/panel crimp connectors (13A max.)           |                | QR/P1       | 49   |
| Rack/panel crimp connectors (3A max.)            | 3A             | QR/P4       | 49   |
| Rack/panel crimp connectors (10A max.)           | 1A             | QR/P6       | 50   |
| Rack/panel crimp connectors (3A max.)            | 3A             | QR/P8       | 50   |

## Connectors compliant to USB 2.0 standard

### UX Series

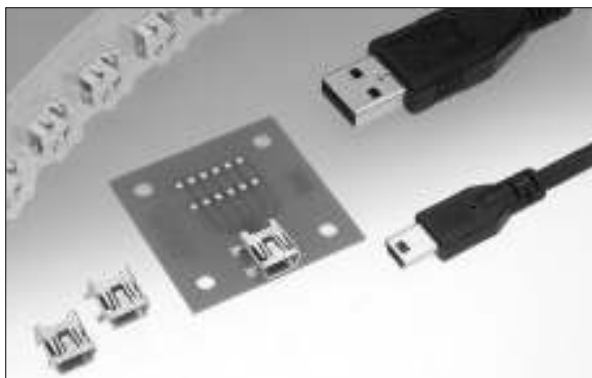

#### Features

- Certified to perform as required in USB 2.0 Standard.
- Performs at transmission speeds up to 480Mbps and ideal for connecting PC peripheral devices.
- The distance between twisted pairs conductors is of equal electrical length, resulting in zero theoretical skew.
- Without using heat shrinkable tubing suppresses impedance disturbance at the terminal section.
- The plug incorporates a build-in snap-lock feature, providing tactile verification of the full and secure mating of plug and receptacle.

#### Applications

PC peripheral devices, Information terminals, PDA's, Digital cameras, MP3 players

#### Specifications

| Item                             | Requirements                            |
|----------------------------------|---|
| No. of Positions                 | 5                                       |
| Current rating (A)               | 1                                       |
| PCB Mount Type                   | SMT, through hole                       |
| Generic Name                     | USB2.0                                  |
| Terminal Pitch (mm)              | 0.8                                     |
| Operating Temperature Range (°C) | -30 to 75                               |
| Insulator                        | Synthetic resin (UL94V-0, Color: Black) |
| Applicable Cable (mm)            | Cable dia.:3.5 to 4.0,4.1 to 4.6        |
| Industry Standard                | USB2.0 UL 94V-0                         |

## Interface connectors for miniature, portable terminal devices

### ST Series

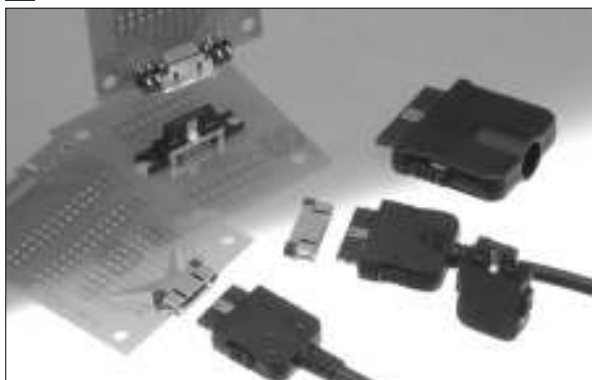

#### Features

- Strong mating strength with solid locking system allows 49N max. pull of X, Y and Z direction.
- 4 keying structure prevents upside down insertion.
- Most suitable for interface of portable equipment.
- A lot of varieties to support various kinds of connections with peripheral equipment.
- Soldering wiring plug is possible to use any type of cables.

#### Applications

Mobile phone, Digital camera, Notebook PC

#### Specifications

| Item                             | Requirements                            |
|----------------------------------|---|
| No. of Positions                 | 4-10-18-22-24-36                        |
| Current rating (A)               | 0.5-1-2                                 |
| PCB Mount Type                   | SMT                                     |
| Terminal Pitch (mm)              | 0.5-1                                   |
| Operating Temperature Range (°C) | -30 to 80                               |
| Insulator                        | Synthetic resin (UL94V-1, Color: Black) |

Circular Connectors

Rectangular Connectors

Coaxial Connectors

Memory Card

Modular Connectors

Card Edge Connectors

Board-to-Board Connectors

Board-to-Wire Connectors

FPC/FFC Connectors

Optical Connectors and Devices

Microwave Components

## Interface connectors for mobile phone

### MQ138 Series



#### Features

- Interface connector for cellular phones.
- Master plug mating with the PDC type cellular phones.
- Used to connect cellular phones and peripheral devices.
- Uses general purpose solder wiring.
- Use of coaxial connectors is possible.

#### Applications

Mobile phone

#### Specifications

| Item                             | Requirements                            |
|----------------------------------|---|
| NO. OF POSITIONS                 | 13                                      |
| Current rating (A)               | 1                                       |
| PCB Mount Type                   | Through hole                            |
| Contact Plating                  | Gold                                    |
| Terminal Pitch (mm)              | 1                                       |
| Operating Temperature Range (°C) | -30 to 70                               |
| Insulator                        | Synthetic resin (UL94V-0, Color: Brown) |
| Applicable Cable (mm)            | Cable dia.:4.8,5.2                      |
| Accessories                      | Bushing, clamp metal, label             |
| Remarks                          | Coaxial connector                       |

## 20,000 times of mating cycle, interface connectors for portable equipment

### 3500 Series

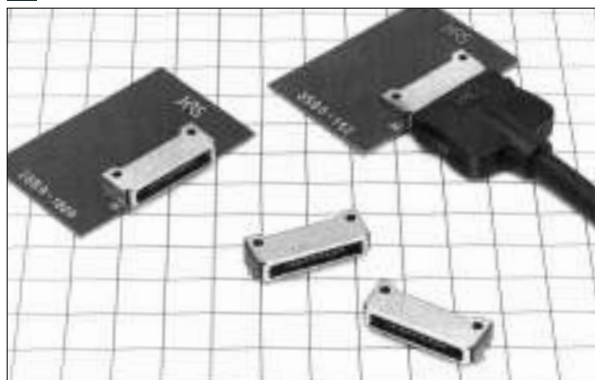

#### Features

- Compact interface connector with shield ensuring insertion and extraction life of 20,000 cycles.
- Contacts' structure of highly reliable, two-contact bellows type.
- Use of a new box-bending structure for the metal shell supporting EMI protection and making a tough connector.
- ESD protection is provided by the over-mold plug cover incorporating an integrated push button structure.

#### Applications

Hand-held terminals, PDA equipment, Notebook PC, Mobile communications equipment, Office equipment, Measurement equipment

#### Specifications

| Item                             | Requirements  |
|----------------------------------|---|
| No. of Positions                 | 10-16   |
| Current rating (A)               | 1   |
| PCB Mount Type                   | SMT   |
| Contact Plating                  | Gold  |
| Terminal Pitch (mm)              | 0.8   |
| Operating Temperature Range (°C) | -40 to 85   |
| Insulator                        | Synthetic resin (UL94V-1, Color: Black)                                     |
| Applicable Cable (mm)            | Conductor:AWG#28(7/0.127) Cable dia.:5mm(10 pos.),Cable dia.:5.9mm(16 pos.) |
| Remarks                          | IDC connection tool, cable clamp tool                                       |

## 0.8mm pitch, SMT ultra small interface connectors 3200 Series

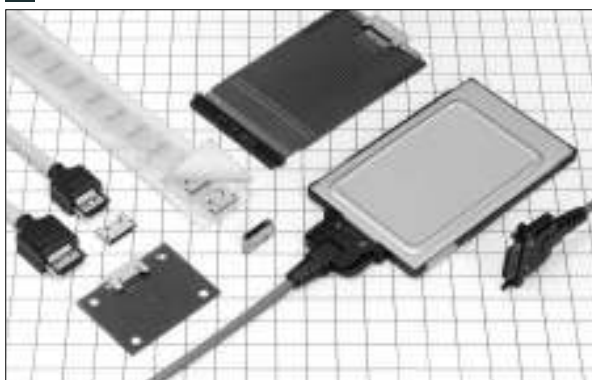

### Features

- Low-profile interface connector that the receptacle is 2.9 mm high from the PCB.
- The molded plug connector is designed to cover the metal shell for electrostatic discharge (ESD) protection.
- 0.8 mm pitch single row SMT ensures ease of PCB mounting.
- Mating with the space-saving latch locks on both sides to support compact design.
- Reinforcing fixtures are available in 0.5, 1, and 1.5 mm lengths depending on PCB thickness.

### Applications

PDA, Office equipment, Mobile communications equipment

### Specifications

| Item                             | Requirements  |
|----------------------------------|---|
| No. of Positions                 | 8-10  |
| Current rating (A)               | 0.5   |
| PCB Mount Type                   | SMT   |
| Terminal Pitch (mm)              | 0.8   |
| Operating Temperature Range (°C) | -30 to 70   |
| Insulator                        | Synthetic resin (UL94V-0, Color: Black)   |
| Applicable Cable (mm)            | Cable dia.:5.2mm max.,Conductor:AWG#28 max.(8 pos.)<br>Cable dia.:5.4mm max.,Conductor:AWG#28 max.(10 pos.) |
| Remarks                          | Cable clamp tool  |

## 1.27mm pitch interface connectors for electrostatic discharge (ESD) protection 3100 Series



### Features

- Low-profile interface connector that the receptacle is 7 mm high from the PCB.
- The molded plug connector is designed to cover the metal shell for electrostatic discharge (ESD) protection.
- The cantilever profile of the female contact ensures low insertion and extraction force with a long life.
- Sequence mechanism to enable the shield to contact first with the mating part.
- The effective mating length is long enough (2 mm).

### Applications

Office equipment, Communications equipment, Electrical household appliances

### Specifications

| Item                             | Requirements  |
|----------------------------------|---|
| No. of Positions                 | 6-8-12-14-16  |
| Current rating (A)               | 0.5   |
| PCB Mount Type                   | Through hole  |
| Contact Plating                  | Gold  |
| Terminal Pitch (mm)              | 1.27  |
| Operating Temperature Range (°C) | -25 to 60   |
| Insulator                        | PBT (UL94V-0, Color: Black), polycarbonate (UL94V-0, Color: Black or White) |
| Applicable Cable (mm)            | Cable clamp dia.:5.8, 6.2, 6.7, 7.0, Conductor:AWG#26 to 30                 |
| Remarks                          | IDC connection tool   |

## 1.78mm pitch connectors for hand-held terminals

### QM Series



#### Features

- The opening and wiring sections of terminals are both in a 1.78-mm grid contact position supports compact and high density.
- Bellows contacts provides excellent mechanical strength against twisting and scooping with 1,000 insertion and extraction times guaranteed.
- IDC cable termination to save wiring effort.
- The dip connectors can be grounded to the PCB to protect from EMI/FRI and snapped onto the PCB.
- Die-cast zinc alloy shell reduces the penetration of internal and external EM noises.

#### Applications

Hand-held terminals, Peripheral and terminal equipment

#### Specifications

| Item                             | Requirements  |
|----------------------------------|---|
| No. of Positions                 | 8-14-26-32  |
| Current rating (A)               | 0.5   |
| PCB Mount Type                   | Through hole  |
| Contact Plating                  | Gold  |
| Terminal Pitch (mm)              | 1.78  |
| Operating Temperature Range (°C) | -55 to 85   |
| Insulator                        | PET (Color: Black)  |
| Applicable Cable (mm)            | 0.89mm pitch ribbon cable (IDC), conductor: AWG#30(7/0.1) |
| Accessories                      | Cover with lock, cover, stopper plate                     |
| Remarks                          | IDC connection tool                                       |

## Micro-miniature interface connectors for AC power supply/signaling

### MQ172 Series

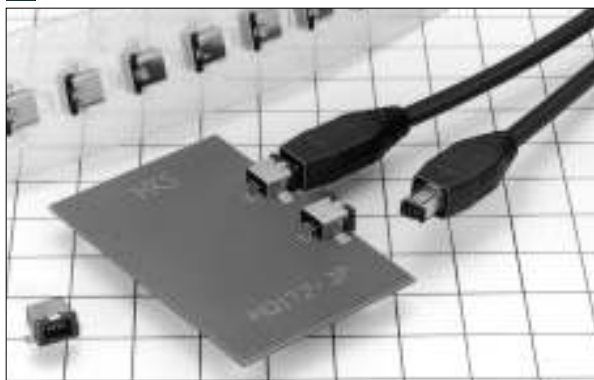

#### Features

- Micro-miniature interface connectors for power supply/signaling.
- Compact, low-height construction (3-contact type) with dimensions of 3.9mm(H) x 6.4mm (W) x 6mm (D).
- The 2-point contact design that provides a contact which is resistant to vibration and shocks.
- Compact yet unique contact design ensures high current capacity (3A for 3-contact type).
- Use of a snap-lock system provides the sensation of locking at the time of insertion.

#### Applications

Personal Digital Assistant (PDA), Mobile Phones, Personal Handyphone System (PHS), Notebook PCs, and Electronic measurement equipment

#### Specifications

| Item                             | Requirements                            |
|----------------------------------|---|
| No. of Positions                 | 3-4                                     |
| Current rating (A)               | 2-3                                     |
| PCB Mount Type                   | SMT                                     |
| Contact Plating                  | Gold                                    |
| Terminal Pitch (mm)              | 0.8                                     |
| Operating Temperature Range (°C) | -30 to 75                               |
| Insulator                        | Synthetic resin (UL94V-0, Color: Black) |
| Applicable Cable (mm)            | Dia.:3.5, Conductor:AWG#24 to 32        |
| Remarks                          | Cable clamp tool                        |

## 0.6mm Pitch, docking station connectors

### EX80 Series



#### Features

- The effective mating length of 1.5mm is long enough for mating/unmating operation.
- Ground terminals placed on both sides of guide boss ensure ground function.
- Plug contacts has 3-step sequence structure including ground contact.
- Supporting 2.5Gbps signal transmission (PCI express).
- Self alignment is +/-1.2mm in the direction of XY (+/-0.7mm for shutter type).

#### Applications

PC, Work Station

#### Specifications

| Item                             | Requirements                        |
|----------------------------------|-------------------------------------|
| No. of Positions                 | 54-100-240                          |
| Current rating (A)               | 0.5                                 |
| PCB Mount Type                   | SMT                                 |
| Contact Plating                  | Gold                                |
| Terminal Pitch (mm)              | 0.6                                 |
| Operating Temperature Range (°C) | -55 to 85                           |
| Insulator                        | LCP                                 |
| Remarks                          | Receptacle (With shutter) available |

## High-speed differential signal connectors

### EXT Series



#### Features

- The construction supports high-speed differential signals such as LVDS, IEEE 1394, and USB 2.0.
- Batch wiring of cables to the plug using solder paste.
- The wiring portion of the plug is secured by the molding which prevents short circuits without the use of shrink tubing.
- The 65-conductor connector incorporates 6 power supply terminals designed to connect 2A power lines.
- The receptacle is made to drop into the board, which results in a height dimension, including the PCB, of 5.6mm.

#### Applications

PCs, Workstations

#### Specifications

| Item                             | Requirements            |
|----------------------------------|-------------------------|
| No. of Positions                 | 65-71                   |
| Current rating (A)               | 0.5                     |
| PCB Mount Type                   | SMT                     |
| Operating Temperature Range (°C) | -55 to 85               |
| Insulator                        | LCP (UL94V-0)           |
| Applicable Cable (mm)            | Insulation dia.0.7 max. |
| Accessories                      | Cover                   |

## D-configuration connectors for digital broadcasting equipment

### DX\*LM Series



#### Features

- D-configuration connector used in connections for digital image broadcast conforming to EIAJ RC-5237 standards.
- Extension of the mating and locking area by 1.5 mm has allowed the DXLM Series to be mounted on panels up to 3 mm thick.
- HIROSE's unique design makes reliable ground connection in sequence, with metal shell first, then the board circuit.
- Deflecting force of the side protrusion on the bottom of the connector provides superior retention to the PCB, thus preventing leaning forward during handling.
- Solid metal grounding posts soldered to the PCB creates extremely strong retention to the PCB.

#### Applications

Digital broadcast TVs, Set top boxes (STB), DVDs, LCD TVs

#### Specifications

| Item                             | Requirements  |
|----------------------------------|---|
| No. of Positions                 | 14  |
| Current rating (A)               | 1   |
| PCB Mount Type                   | Through hole  |
| Generic Name                     | D-configuration Connectors  |
| Terminal Pitch (mm)              | 1.27  |
| Operating Temperature Range (°C) | -25 to 70   |
| Insulator                        | PBT (UL94V-0, Color: Black)                                       |
| Applicable Cable (mm)            | Conductor:AWG#30(7/0.1),AWG#28(7/0.127),Conductor:AWG#28(7/0.127) |

## Connectors compliant to ANSI SCSI standard

### DX\*M Series

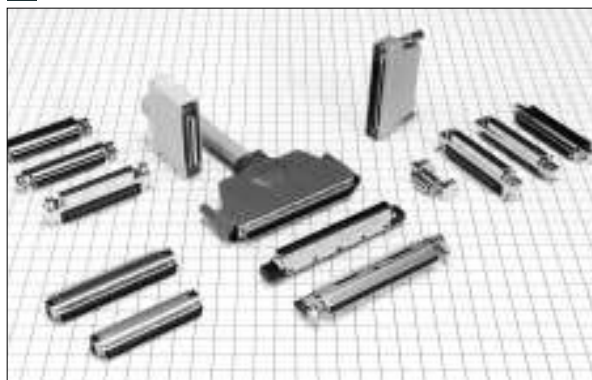

#### Features

- Ribbon (bellows) contacts provides excellent mechanical strength with smooth insertion and extraction.
- At the time of mating, the shell contacts earlier than the terminals, thus preventing the set from breaking due to static electricity.
- Die-cast zinc or stainless steel cover case prevents noise.
- Right angle dip type with ferrite incorporated for noise prevention.
- The ESD protection over mold cover case is provided with a one-touch lock and screw lock.

#### Applications

Computers, Office equipment, Measurement equipment, Communications equipment, Control equipment, FA equipment

#### Specifications

| Item                             | Requirements   |
|----------------------------------|--|
| No. of Positions                 | 14-20-26-36-50-68-80-100-110   |
| Current rating (A)               | 0.5  |
| PCB Mount Type                   | Through hole   |
| Generic Name                     | Half pitch connector   |
| Contact Plating                  | Gold   |
| Terminal Pitch (mm)              | 1.27   |
| Operating Temperature Range (°C) | -55-0 to 50-85   |
| Insulator                        | Synthetic resin  |
| Applicable Cable (mm)            | (I/O cable)Conductor:AWG#30(7/0.1),AWG#28(7/0.127),(Ribbon cable)Conductor:AWG#28(7/0.127) |
| Accessories                      | Cover, termination   |
| Remarks                          | IDC connection tool, automatic discrete cable combing machine                              |



## 1.27mm pitch IDC connectors

### DX Series



#### Features

- Ribbon (bellows) contacts provides excellent mechanical strength with smooth insertion and extraction.
- At the time of mating, the shell contacts earlier than the terminals, thus preventing the set from breaking due to static electricity.
- Die-cast zinc alloy cover case and receptacle shell are sturdy and reduce the penetration of external EM noise.
- The effective contact length is 2.3 mm with excellent contact stability.
- Plug and receptacle shells for coaxial contacts for radio frequency use and a shielded plug-in models for unit-to-unit connections are available.

#### Applications

Computers, Office equipment, Measurement equipment, Communications equipment, Control equipment, FA equipment

#### Specifications

| Item                             | Requirements   |
|----------------------------------|--|
| No. of Positions                 | 20-26-28-36-50-60-68-80-100-132 3(Coaxial connector type only)                                     |
| Current rating (A)               | 0.5  |
| PCB Mount Type                   | Through hole   |
| Contact Plating                  | Gold   |
| Terminal Pitch (mm)              | 1.27   |
| Operating Temperature Range (°C) | -55 to 85  |
| Insulator                        | PBT or substitute (UL94V-0, Color: Black)  |
| Applicable Cable (mm)            | (I/O cable)Conductor:AWG#30(7/0.1),AWG#28(7/0.127),(Ribbon cable)Conductor:AWG#28(19/0.08,7/0.127) |
| Accessories                      | Cover, cap   |
| Remarks                          | IDC connection tool, automatic discrete cable combing machine                                      |

## Ribbon contact connectors

### RC Series

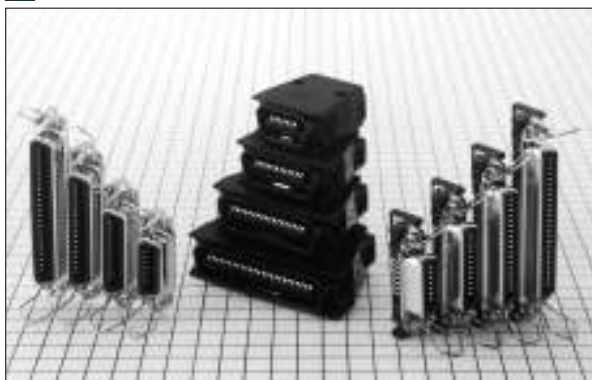

#### Features

- Ribbon contact connector.
- Ideally suited for printer interface (conforming to CENTRONICS standards).
- Products with EMI (electromagnetic interference) protection are available.
- UL-approved products are available.
- Products with electrostatic discharge (ESD) protection are available.

#### Applications

Computers, Peripherals and terminals, Communications equipment, Printer interface

#### Specifications

| Item                             | Requirements  |
|----------------------------------|---|
| No. of Positions                 | 14-24-36-50   |
| Current rating (A)               | 1-3   |
| PCB Mount Type                   | Through hole  |
| Generic Name                     | Centronics (36 pos.)  |
| Contact Plating                  | Gold  |
| Terminal Pitch (mm)              | 2.16  |
| Operating Temperature Range (°C) | -55 to 85   |
| Insulator                        | PBT (UL94V-0, Color: Black)   |
| Applicable Cable (mm)            | 1.27mm pitch ribbon cable,Conductor:AWG#28(7/0.127)   |
| Industry Standard                | IEEE UL   |
| Accessories                      | Cap (36 pos.), cover  |
| Remarks                          | With ferrite type (RC10(F) series), electrostatic protection type (RC10H series), IDC connection tool |

Circular Connectors

Rectangular Connectors

Coaxial Connectors

Memory Card

Modular Connectors

Card Edge Connectors

Board-to-Board Connectors

Board-to-Wire Connectors

FPC/FPC Connectors

Optical Connectors and Devices

Microwave Components

## 2.54mm pitch crimp/IDC connectors

### DN Series

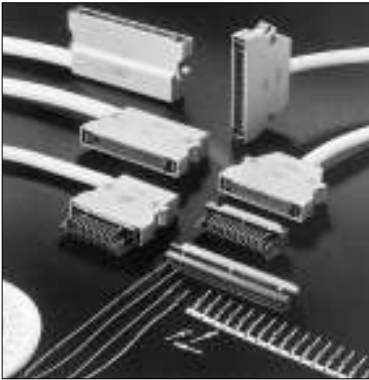

#### Features

- 2.54-mm grid contact position can be directly dip-soldered to PCBs.
- One-touch lock mechanism ensures perfect operation.
- The cover case is made of die-cast aluminum to shield against electromagnetic waves, which ensures noise prevention.
- Provided with a dip soldering connector incorporating a snap clamp for temporarily fixing the connector on the PCB.
- Stable quality due to the contact design based on HIROSE's field-proven SM series (D sub connectors).

#### Applications

Office equipment, Communications equipment, Measurement equipment, Control equipment, FA equipment

#### Specifications

| Item                             | Requirements  |
|----------------------------------|---|
| No. of Positions                 | 20-26-36-50   |
| Current rating (A)               | 3   |
| PCB Mount Type                   | Through hole  |
| Contact Plating                  | Gold  |
| Terminal Pitch (mm)              | 2.54  |
| Operating Temperature Range (°C) | -55 to 85   |
| Insulator                        | PBT (UL94V-0, Color: Black)   |
| Applicable Cable (mm)            | (IDC)1.27mm pitch ribbon cable, Conductor:AWG#28(7/0.127),AWG#26(7/0.16)<br>(Crimp)AWG#26 to 28 |
| Accessories                      | Cover   |
| Remarks                          | Automatic crimp machine, crimp tool, IDC connection tool  |

## D-sub right angle receptacle

### RD\*D Series

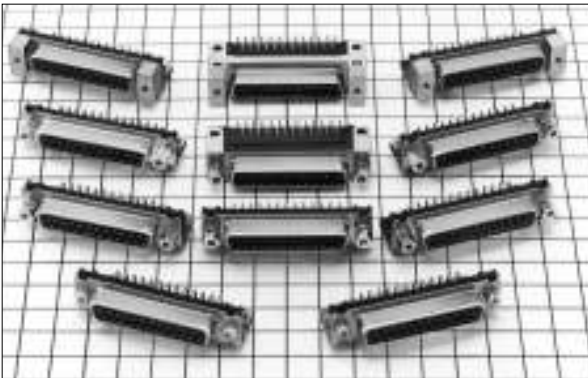

#### Features

- Simple construction of single mold.
- Designed to be directly connected to the circuits on PCBs in parallel, which ensures high-density mounting and allows convenience of cable plug connection.
- Provided with rectangular and hexagonal mating locking bases and a simple lock pin to tack on PCB.
- Saves gold by plating contacts with gold and PCB-contacting parts with solder.
- Various accessories, such as a dedicated mating locking screw and a mis-insertion prevention pin, are available.

#### Applications

Computers, Peripherals and terminals, Control equipment, Measurement equipment, Communications equipment, FA equipment

#### Specifications

| Item                             | Requirements                                     |
|----------------------------------|--|
| No. of Positions                 | 9-15-25-37                                       |
| Current rating (A)               | 3  |
| PCB Mount Type                   | Through hole                                     |
| Generic Name                     | D-sub connector                                  |
| Contact Plating                  | Gold   |
| Terminal Pitch (mm)              | 2.74-2.77  |
| Operating Temperature Range (°C) | -55 to 85  |
| Insulator                        | PBT (UL94V-0, Color: Black)                      |
| Industry Standard                | MIL  |
| Accessories                      | Mis-insertion prevention pin, locking screw, cap |

## D-sub space saving type receptacle

### RD\*G Series

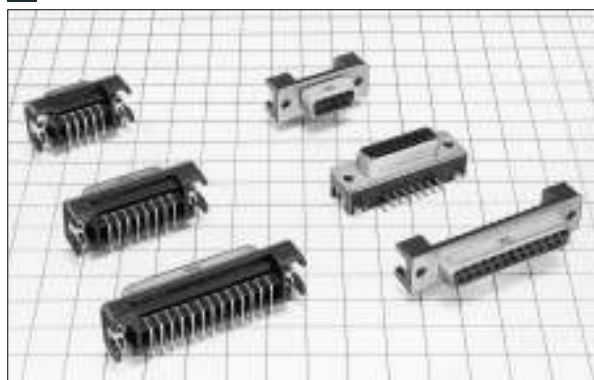

#### Features

- 35% space-saving achieved in the depth and mounting area with a weight reduction of approximately 10% in comparison with the conventional RD\*D model.
- For smoother insertion and withdrawal, reliable partly gold-plated tulip-shaped contacts are used.
- The lock pin grounding system that solders directly to the PCB eliminates screws to secure the PCB.
- A lock pin length for 1.2- and 1.6-mm-thick PCBs with a dip post length of 3.5 or 2.8 mm.
- Connector design allows ease of robotic insertion.

#### Applications

Computers, Peripherals and terminals, Control equipment, Measurement equipment, Communications equipment, FA equipment

#### Specifications

| Item                             | Requirements                                     |
|----------------------------------|--|
| No. of Positions                 | 9-15-25  |
| Current rating (A)               | 3  |
| PCB Mount Type                   | Through hole                                     |
| Generic Name                     | D-sub connector                                  |
| Terminal Pitch (mm)              | 2.74-2.77  |
| Operating Temperature Range (°C) | -55 to 85  |
| Insulator                        | PBT (UL94V-0, Color: Black)                      |
| Industry Standard                | MIL  |
| Accessories                      | Mis-insertion prevention pin, locking screw, cap |
| Remarks                          | Space saving type                                |

## D-sub receptacle with a built-in ferrite core

### RD\*F Series

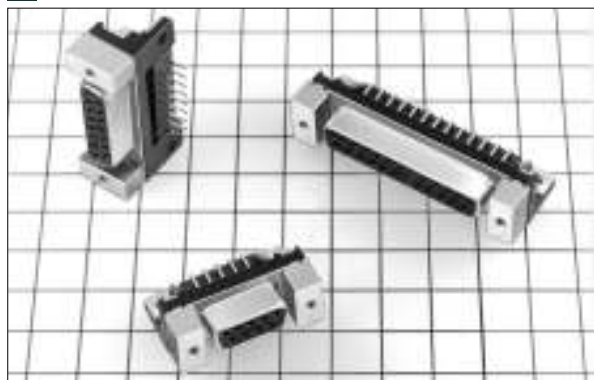

#### Features

- Conventional RD\*D model with a built-in ferrite core for EMI protection.
- The ferrite effectively attenuates conduction noise.
- The same as the conventional RD\*D model in mounting dimension and PCB hole pattern.
- Provided with a hexagonal mating locking base.
- Products with simple lock pins to tack on PCB. are available.

#### Applications

Computers, Peripherals and terminals, Control equipment, Measurement equipment, Communications equipment, FA equipment

#### Specifications

| Item                             | Requirements                                     |
|----------------------------------|--|
| No. of Positions                 | 9-15-25  |
| Current rating (A)               | 3  |
| PCB Mount Type                   | Through hole                                     |
| Generic Name                     | D-sub connector                                  |
| Contact Plating                  | Gold   |
| Terminal Pitch (mm)              | 2.74-2.77  |
| Operating Temperature Range (°C) | -55 to 85  |
| Insulator                        | PBT (UL94V-0, Color: Black)                      |
| Industry Standard                | MIL  |
| Accessories                      | Mis-insertion prevention pin, locking screw, cap |
| Remarks                          | With ferrite type                                |

Circular Connectors

Rectangular Connectors

Coaxial Connectors

Memory Card

Modular Connectors

Card Edge Connectors

Board-to-Board Connectors

Board-to-Wire Connectors

FPC/FFC Connectors

Optical Connectors and Devices

Microwave Components

## D-sub right angle receptacle RD\*B Series

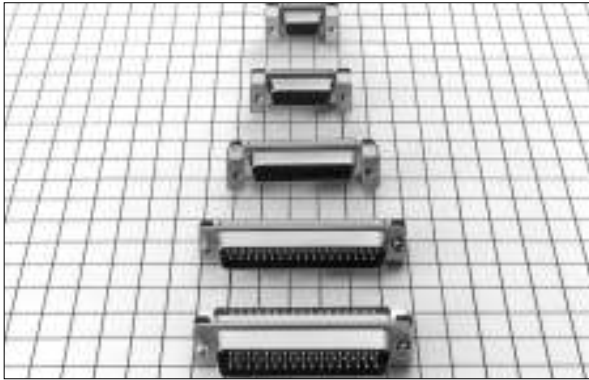

### Features

- Mounted in parallel on the PCB for ease of connection to the cable plug.
- High-density mounting enabled by direct connection to the circuit on the PCB.
- UL-approved synthetic resin provides superior heat and chemical resistance.
- For smoother insertion and withdrawal, reliable partly gold-plated tulip-shaped contacts are used.
- A wide variety of combinations with cable connectors available, such as soldering, crimping, and ribbon IDC termination.

### Applications

Computers, Peripherals and terminals, Control equipment, Measurement equipment, Communications equipment, FA equipment

### Specifications

| Item                             | Requirements                                     |
|----------------------------------|--|
| No. of Positions                 | 9-15-25-37-50                                    |
| Current rating (A)               | 3  |
| PCB Mount Type                   | Through hole                                     |
| Generic Name                     | D-sub connector                                  |
| Contact Plating                  | Gold   |
| Terminal Pitch (mm)              | 2.74-2.77  |
| Operating Temperature Range (°C) | -55 to 85  |
| Insulator                        | PBT (UL94V-0, Color: Black)                      |
| Industry Standard                | MIL  |
| Accessories                      | Mis-insertion prevention pin, locking screw, cap |

## D-sub straight through hole type connectors SD Series

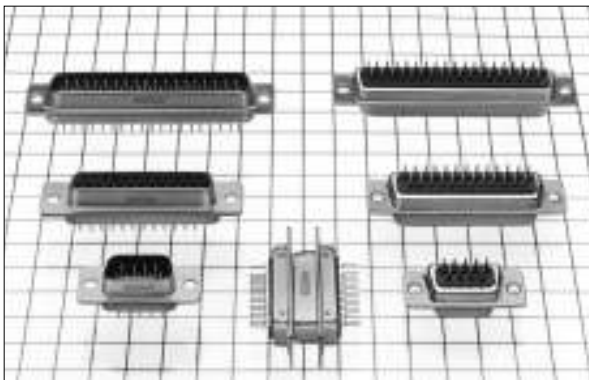

### Features

- D-sub connectors designed to be mounted vertically to PCBs.
- Saves gold by plating contacts with gold and PCB-contacting parts with solder.
- Directly mountable on PCBs for mounting labor saving in high density and easily connectable to cable plugs.
- A wide variety of combinations with cable connectors available, such as soldering, crimping, and ribbon IDC termination.
- Uses insulation made from highly heat- and chemical-resistant glass-containing PBT resin (UL94V-0).

### Applications

Computers, Peripherals and terminals, Control equipment, Measurement equipment, Communications equipment, FA equipment

### Specifications

| Item                             | Requirements                                  |
|----------------------------------|---|
| No. of Positions                 | 9-15-25-37-50                                 |
| Current rating (A)               | 3   |
| PCB Mount Type                   | Through hole                                  |
| Generic Name                     | D-sub connector                               |
| Contact Plating                  | Gold  |
| Terminal Pitch (mm)              | 2.74-2.77                                     |
| Operating Temperature Range (°C) | -55 to 85                                     |
| Insulator                        | PBT (UL94V-0, Color: Black)                   |
| Industry Standard                | MIL   |
| Accessories                      | Spring lock, sliding lock, locking screw, cap |

## D-sub solder type connectors

### HD Series



#### Features

- Press pin type ensures ease of soldering of a variety of stranded and solid wires.
- Wiring side of solder cup construction ensures ease of wiring work up to a wire size of AWG#20.
- A dimple-processed shell is available for improvement in mating and conductivity.
- Uses insulation made from highly heat- and chemical-resistant glass-containing PBT resin (UL94V-0).
- Various plug cases, such as CTF and CTH, are available.

#### Applications

Computers, Peripherals and terminals, Control equipment, Measurement equipment, Communications equipment, FA equipment

#### Specifications

| Item                             | Requirements  |
|----------------------------------|---|
| No. of Positions                 | 9-15-25-37-50   |
| Current rating (A)               | 3   |
| Generic Name                     | D-sub connector   |
| Contact Plating                  | Gold  |
| Terminal Pitch (mm)              | 2.74-2.77   |
| Operating Temperature Range (°C) | -55 to 85   |
| Insulator                        | PBT (UL94V-0, Color: Black)   |
| Industry Standard                | MIL   |
| Accessories                      | Spring lock, sliding lock, screw lock, locking screw, clamp, cap, cover |

## D-sub connectors, IDC termination

### FD\*D Series

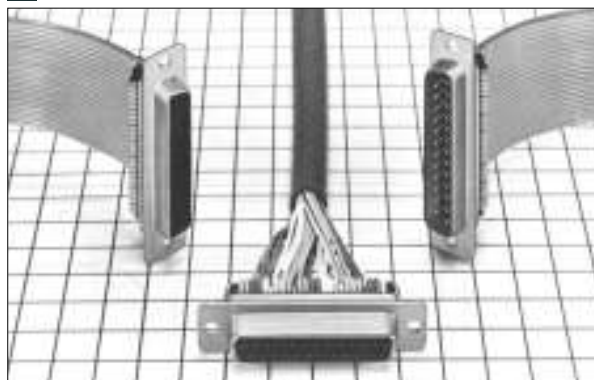

#### Features

- D-sub connector for 1.27mm pitch and 1.38mm pitch ribbon cable IDC termination.
- Cable termination side is 30% lower-profile in comparison with FD series, ideal for the downsizing of the equipment.
- The cable IDC pitch is 1.38 mm, but IDC pitch of 1.27 mm is possible with a cable slit jig used.
- The presser plate of the ribbon cable is fixed with a metal bar strongly and securely.
- Discrete cable can be pressed to the low-profile model with a multi-core cable crimping device.

#### Applications

Computers, Peripherals and terminals, Control equipment, Measurement equipment, Communications equipment, FA equipment

#### Specifications

| Item                             | Requirements  |
|----------------------------------|---|
| No. of Positions                 | 9-15-25-37  |
| Current rating (A)               | 1   |
| Generic Name                     | D-sub connector   |
| Contact Plating                  | Gold  |
| Terminal Pitch (mm)              | 2.74-2.77   |
| Operating Temperature Range (°C) | -55 to 85   |
| Insulator                        | PBT (UL94V-0, Color: Black)   |
| Applicable Cable (mm)            | 1.27mm or 1.38mm pitch ribbon cable, Conductor: AWG#28(7/0.127)         |
| Industry Standard                | MIL   |
| Accessories                      | Spring lock, sliding lock, screw lock, locking screw, clamp, cap, cover |
| Remarks                          | IDC connection tool   |

## D-sub connectors, IDC termination

### FD Series

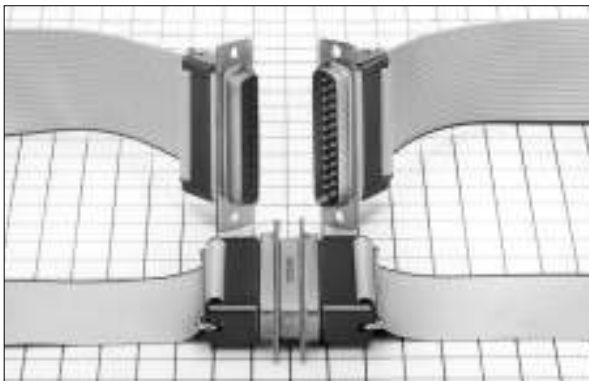

#### Features

- D-sub connector for 1.27mm pitch standard ribbon cable IDC termination.
- Fixes the cable securely by fixing the ribbon cable clamp with a metal plate in the connector.
- The connector can be chassis- or panel-mounted on the front or back.
- The cable IDC pitch is 1.27 mm (standard) for ease of connecting standard ribbon cables.
- Ease to connect cables by following the same IDC termination and connection procedures as those for HIROSE's other ribbon cable connectors. Special pressing of connection wire only for this series is not required.

#### Applications

Computers, Peripherals and terminals, Control equipment, Measurement equipment, Communications equipment, FA equipment

#### Specifications

| Item                             | Requirements  |
|----------------------------------|---|
| No. of Positions                 | 9-15-25-37  |
| Current rating (A)               | 1   |
| Generic Name                     | D-sub connector   |
| Contact Plating                  | Gold  |
| Terminal Pitch (mm)              | 2.74-2.77   |
| Operating Temperature Range (°C) | -55 to 85   |
| Insulator                        | PBT (UL94V-0, Color: Black)   |
| Applicable Cable (mm)            | 1.27mm or 1.38mm pitch ribbon cable, Conductor: AWG#28(7/0.127)         |
| Industry Standard                | MIL   |
| Accessories                      | Spring lock, sliding lock, screw lock, locking screw, clamp, cap, cover |
| Remarks                          | IDC connection tool   |

## D-sub crimp type connectors

### CD Series

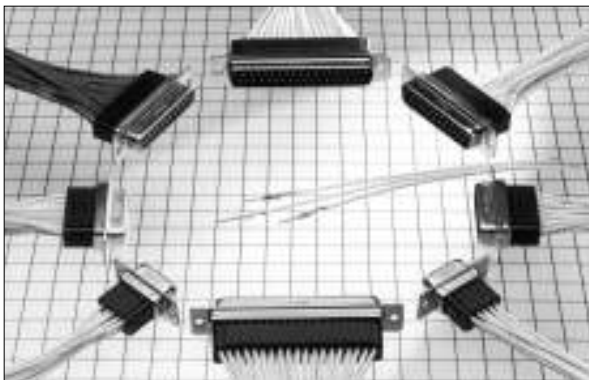

#### Features

- SM-series (D-sub) crimp-type connectors.
- A dimple-processed shell is available for improvement in mating and conductivity.
- The connector can be chassis- or panel-mounted on the front or back.
- Requires no special withdrawal jig (push the retainers from the connector side to insert or withdraw the connector).
- Uses an insulator made from highly heat- and chemical-resistant UL-approved PBT synthetic resin.

#### Applications

Computers, Peripherals and terminals, Control equipment, Measurement equipment, Communications equipment, FA equipment

#### Specifications

| Item                             | Requirements  |
|----------------------------------|---|
| No. of Positions                 | 9-15-25-37  |
| Current rating (A)               | 3   |
| Generic Name                     | D-sub connector   |
| Contact Plating                  | Gold  |
| Terminal Pitch (mm)              | 2.74-2.77   |
| Operating Temperature Range (°C) | -55 to 85   |
| Insulator                        | PBT (UL94V-0, Color: Black)   |
| Applicable Cable (mm)            | Conductor: AWG#20 to 24 ,AWG#24 to 28                                   |
| Industry Standard                | MIL   |
| Accessories                      | Spring lock, sliding lock, screw lock, locking screw, clamp, cap, cover |
| Remarks                          | Automatic crimp machine, crimp tool                                     |

Circular Connectors  
Rectangular Connectors  
Coaxial Connectors  
Memory Card  
Modular Connectors  
Card Edge Connectors  
Board-to-Board Connectors  
Board-to-Wire Connectors  
FPC/FFC Connectors  
Optical Connectors and Devices  
Microwave Components

## D-sub connectors with coaxial contact

### JDM Series



#### Features

- Connector unit with a coaxial cable insertion hole on the shell that is as large as the D-sub connector.
- Available in various types of soldering coaxial contact including straight dip soldering and right angle dip soldering, and compatible with all types of housing.
- EMI protection with the use of a dedicated plug case made of a die-cast zinc alloy.
- Compact and sturdy metal shell.
- Uses insulation made from highly heat- and chemical-resistant epoxy and PPS resins.

#### Applications

Computers, Peripherals and terminals, Control equipment, Measurement equipment, Communications equipment, FA equipment

#### Specifications

| Item                             | Requirements   |
|----------------------------------|--|
| No. of Positions                 | 5W1,7W2,3W3,25W3,27W2  |
| Current rating (A)               | 5  |
| PCB Mount Type                   | Through hole   |
| Generic Name                     | D-sub connector  |
| Contact Plating                  | Gold   |
| Operating Temperature Range (°C) | -55 to 85  |
| Insulator                        | Epoxy, PPS   |
| Applicable Cable (mm)            | RG-196/U,2.5C-2V, RG-187/U, RG-188/U, 1.5C-2V, 1.5D-QEW, RG-58/U |
| Industry Standard                | MIL-MIL, NDS   |
| Accessories                      | Coaxial connector, cover   |
| Remarks                          | Coaxial connector extraction tool                                |

Note: 5W1 indicates 4: signal, 1: coaxial contact.

## D-sub cover for electromagnetic interference (EMI) protection

### CTH Series

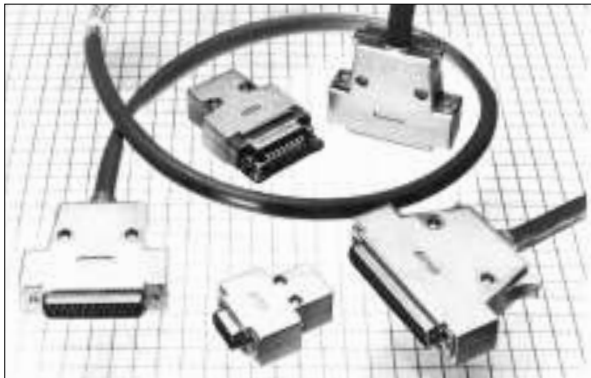

#### Features

- Plug case with electromagnetic interference (EMI) protection.
- Standard screw-type locking mechanism providing a strong and secure lock.
- Plated (UL746C) ABS resin (UL94V-2) enables strong and excellent shielding characteristics.
- Enhanced shielding effectiveness by clamping the cable shielding part with two types of clamps sandwiched between the plug cases.
- The clamp has a screw to ground the drain wire.

#### Applications

Computers, Peripherals and terminals, Control equipment, Measurement equipment, Communications equipment, FA equipment

#### Specifications

| Item                             | Requirements          |
|----------------------------------|-----------------------|
| No. of Positions                 | 9-15-25-37            |
| Generic Name                     | D-sub cover           |
| Operating Temperature Range (°C) | -55 to 85             |
| Applicable Cable (mm)            | Dia.: 7 to 12         |
| Insulator                        | ABS                   |
| Industry Standard                | MIL                   |
| Accessories                      | Screw lock            |
| Remarks                          | Finish: Nickel plated |

- Circular Connectors
- Rectangular Connectors
- Coaxial Connectors
- Memory Card
- Modular Connectors
- Card Edge Connectors
- Board-to-Board Connectors
- Board-to-Wire Connectors
- FPC/FFC Connectors
- Optical Connectors and Devices
- Microwave Components

## D-sub plastic cover CTF Series

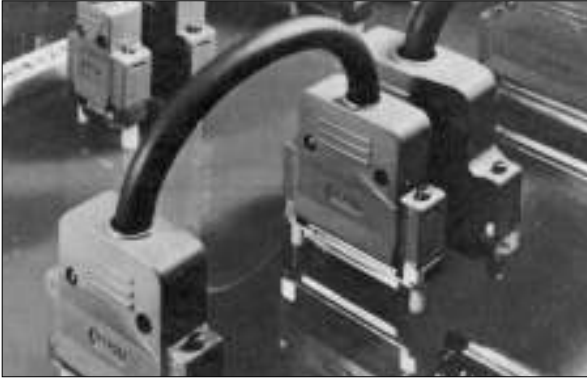

### Features

- Screw type locking mechanism for plug case provides a strong and secure lock.
- The plug case material is made of ABS resin that is lightweight and sturdy.
- Spring locking, sliding locking, and screw locking mechanism as D-sub accessories are available.
- A clamp metal and dust cap as D-sub accessories are available.
- Rectangular and hexagonal locking devices are selectable according to the panel mounting style.

### Applications

Computers, Peripherals and terminals, Control equipment, Measurement equipment, Communications equipment, FA equipment

### Specifications

| Item                             | Requirements          |
|----------------------------------|-----------------------|
| No. of Positions                 | 9-15-25-37-50         |
| Generic Name                     | D-sub cover           |
| Operating Temperature Range (°C) | -55 to 85             |
| Insulator                        | ABS (2.5PB 6/2 color) |
| Applicable Cable (mm)            | Dia.:7 to 12          |
| Accessories                      | Screw lock            |
| Remarks                          | Material: ABS         |

## Large current connector PS Series



### Features

- Compound of 2 types of power supply contacts corresponding to IN and OUT current capacity in rectification unit of power supply equipment and signal contacts to control units.
- 3-step sequence can be chosen with sequence structure power contacts.
- Hot plug of low power supply contacts is the measure for charge.
- Bellows structure of signal contacts prevent buckling.
- Reliable crimping connection with cables.

### Applications

Power supply connector for industrial equipment

### Specifications

| Item                             | Requirements                        |
|----------------------------------|-------------------------------------|
| No. of Positions                 | 2-42(Power 4, single 32, power 4)   |
| Current rating (A)               | 2.5-50-200                          |
| Operating Temperature Range (°C) | -55 to 125                          |
| Insulator                        | RBT (UL94V-0)                       |
| Accessories                      | Floating screw, dust cap, partition |



## Hirose Unique Samicon connectors

### 1600 Series



#### Features

- HIROSE's originally designed connector.
- Products conforming to NTT specifications (Spec number 1931) are available.
- No plug cases or stopper brackets are required with the plastic lock used.
- Combinations in a wide variety are possible as required, such as soldering, wrapping, and crimping cable connector mated with dip connector.
- Uses insulation made from highly heat- and chemical-resistant materials.

#### Applications

Computers, Peripherals and terminals, Control equipment, Measurement equipment, Signal devices, Communications equipment, Office equipment

#### Specifications

| Item                  | Requirements   |
|-----------------------|--|
| No. of Positions      | 8-12-16-20-24-28-34-45-60  |
| Current rating (A)    | 3  |
| PCB Mount Type        | Through hole   |
| Generic Name          | Samicon  |
| Contact Plating       | Gold, silver   |
| Terminal Pitch (mm)   | 2.5  |
| Insulator             | Diallyl phthalate (glass reinforced, color: blue)  |
| Applicable Cable (mm) | Conductor:(Wrapping)AWG#26 to 30 Solid wire,(Crimp)AWG#24 to 28                          |
| Industry Standard     | NTT  |
| Accessories           | Cover, stopper bracket, cap, stopper, handle, deep bracket, plastic lock, polarizing key |
| Remarks               | Crimp tool, contact extraction tool  |

## Hirose Unique Minicon connectors

### 1300 Series

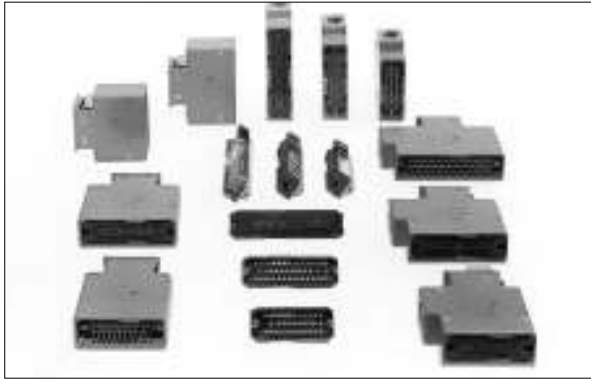

#### Features

- Products conforming to NTT specifications (Spec number 1931) are available.
- The plug case is rugged and has a push-button lock mechanism to ensure reliable connection.
- The plug case is of side-locking and top-touch locking type (NTT spec and HIROSE's original).
- The top-touch locking plug case made of ABS resin is lightweight and sturdy with a holding strength of 30 kg.
- HIROSE's original side locking plug case has a cable inlet opening for both vertical and horizontal.

#### Applications

NTT touch-tone telephones, NTT station equipment, Data communications indoor equipment

#### Specifications

| Item                  | Requirements                               |
|-----------------------|--|
| No. of Positions      | 4-6-8-12-16-20-24-28-34-45-60              |
| Current rating (A)    | 5  |
| PCB Mount Type        | Through hole                               |
| Generic Name          | Minicon                                    |
| Contact Plating       | Gold, silver                               |
| Terminal Pitch (mm)   | 3.5  |
| Insulator             | Epoxy (Color: greenish brown)              |
| Applicable Cable (mm) | Conductor:(Wrapping)0.32 to 0.5 Solid wire |
| Industry Standard     | NTT  |
| Accessories           | Cover, stopper bracket, handle             |

## Power supply connectors for industrial equipment

### PX Series



#### Features

- Large-current power supply connector withstanding a voltage of 2200V AC max. and a rated current of 10A/contact (60A/6 contacts).
- The opening section is keyed to prevent misalignment of plugs in parallel applications.
- Three point contact terminals with gold plating is environment resistant and ensures high reliability.
- Use of dedicated crimping tools will make harness work easier. One tool crimps both AWG#16 and AWG#18 wire.
- Release of contact lock can easily be performed with dedicated jig, which facilitates the wiring modification after assembly.

#### Applications

Power supply connector for industrial equipment

#### Specifications

| Item                             | Requirements   |
|----------------------------------|--|
| No. of Positions                 | 4-6-8-12   |
| Current rating (A)               | 10   |
| PCB Mount Type                   | Through hole   |
| Contact Plating                  | Gold   |
| Operating Temperature Range (°C) | -55 to 105   |
| Insulator                        | PBT (UL94V-0)  |
| Applicable Cable (mm)            | Conductor:AWG#16,18  |
| Industry Standard                | UL,CSA,TUV   |
| Accessories                      | Simple type plug holder cover                                |
| Remarks                          | Automatic crimp machine, crimp tool, contact extraction tool |

## Rack/panel crimp connectors (13A max.)

### QR/P Series



#### Features

- Plug-in connection rectangular multi-contact rack/panel connector. Connects or disconnects the power supply or signal circuits between the unit and rack.
- The crimp-type pins are bellows sexless contact with smooth insertion and extraction ensured, while a stable contact pressure is ensured with a wide contact area.
- The two pairs of opposed contacts at both ends (4 electrodes) in the housing are spaced apart from signal contacts for power circuits.
- The metal guide pin withstands coupling shock.
- The receptacle housing is fixed securely to the panel or rack through floating bushings to ensure smooth insertion and extraction.

#### Applications

PPC, communications equipment, Automatic vending machines, Measurement equipment, Industrial equipment, Distribution boards

#### Specifications

| Item                             | Requirements   |
|----------------------------------|--|
| No. of Positions                 | 4-8-12-16-24   |
| Current rating (A)               | 7-13   |
| Contact Plating                  | Gold   |
| Operating Temperature Range (°C) | -10 to 60  |
| Insulator                        | PBT (UL94V-0, Color: Blue)                                       |
| Applicable Cable (mm)            | Conductor:AWG#14 to 16,AWG#18 to 24                              |
| Industry Standard                | UL,CSA,TUV   |
| Remarks                          | Automatic crimp machine, crimp tool, applicator, extraction tool |

## Rack/panel crimp connectors (13A max.)

### QR/P1 Series



#### Features

- Compact type of plug-in connection rectangular multi-contact rack/panel connector QR/P for high-density mounting.
- Blade contacts ensure dealing with tolerance of the coupling length.
- Compact crimping contacts due to separate power contacts from signal contacts.
- One opposed pair (in 12 contacts), 2 pairs (in 8, 16, and 24 contacts), and 3 pairs (in 32 contacts) are spaced apart from signal contacts so that they can be used as power supply contacts.
- Guide pins are metal to be strong against accidental coupling shock, and receptacle securely mounted to the panel or rack through floating bushings to ensure smooth insertion and extraction.

#### Applications

PPC, communications equipment, Automatic vending machines, Measurement equipment, Industrial equipment, Distribution boards

#### Specifications

| Item                             | Requirements  |
|----------------------------------|---|
| No. of Positions                 | 8-12-16-24-32   |
| Current rating (A)               | Signal 3A, Power 13A  |
| Contact Plating                  | Gold  |
| Operating Temperature Range (°C) | -10 to 60   |
| Insulator                        | PBT (UL94V-0, Color: Black)   |
| Applicable Cable (mm)            | Conductor:(For power)AWG#14 to 16,AWG#18 to #24<br>(For signal)AWG#20 to 24,AWG#24 to #28 |
| Industry Standard                | UL,CSA,TUV  |
| Remarks                          | Automatic crimp machine, crimp tool, applicator, extraction tool                          |

## Rack/panel crimp connectors (3A max.)

### QR/P4 Series



#### Features

- Compact type of plug-in connection rectangular multi-contact rack/panel connector QR/P1 for high-density mounting.
- Compact design with guide pins integrated with insulator.
- The connectors mounted to racks or panels with stepped screws and surface terminal contact ensure ease of insertion and extraction.
- Approved by UL, CSA, and TÜV (partly). Uses flame-retardant insulator (UL94V-0).
- The female housing construction is available to finger test (conforming to UL standard 1950).

#### Applications

PPC, communications equipment, Automatic vending machines, Measurement equipment, Industrial equipment, Distribution boards

#### Specifications

| Item                             | Requirements   |
|----------------------------------|--|
| No. of Positions                 | 8-12-16-24-32-40   |
| Current rating (A)               | 3  |
| Operating Temperature Range (°C) | -10 to 60  |
| Insulator                        | PBT (UL94V-0, Color: Black)                                      |
| Applicable Cable (mm)            | Conductor:AWG#20 to 24,AWG#24 to 28                              |
| Industry Standard                | UL,CSA,TUV   |
| Remarks                          | Automatic crimp machine, crimp tool, applicator, extraction tool |

Circular Connectors

Rectangular Connectors

Coaxial Connectors

Memory Card

Modular Connectors

Card Edge Connectors

Board-to-Board Connectors

Board-to-Wire Connectors

FFC/FFC Connectors

Optical Connectors and Devices

Microwave Components

## Rack/panel crimp connectors (10A max.)

### QR/P6 Series

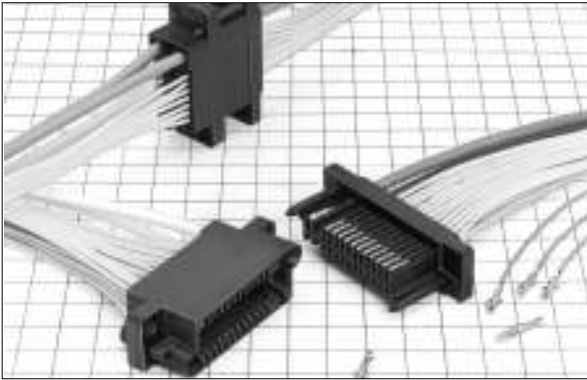

#### Features

- Compact type of plug-in connection rectangular multi-contact rack/panel connector QR/P1 for high-density mounting.
- Approved by UL, CSA, and TÜV.
- The opposed contacts at one end of the connector in the housing are used for power supply. Uses flame-retardant insulator (UL94V-0).
- Separate crimping terminals for power supply use and signal use. Compact design the guide pins integrated with insulator.
- Blade contacts ensure dealing with tolerance of the coupling length, and connectors are mounted to racks or panels with stepped screws for easy mating and unmating.

#### Applications

PPC, communications equipment, Automatic vending machines, Measurement equipment, Industrial equipment, Distribution boards

#### Specifications

| Item                             | Requirements  |
|----------------------------------|---|
| No. of Positions                 | 6-12-16-24  |
| Current rating (A)               | Signal 3A, Power 13A  |
| Operating Temperature Range (°C) | -25 to 120  |
| Insulator                        | PBT (UL94V-0, Color: Black)   |
| Applicable Cable (mm)            | Conductor:(For power)AWG#14 to 16,AWG#18 to #24<br>(For signal)AWG#24 to 28 |
| Industry Standard                | UL,CSA,TUV  |
| Remarks                          | Automatic crimp machine, crimp tool, applicator, extraction tool            |

## Rack/panel crimp connectors (3A max.)

### QR/P8 Series



#### Features

- The plug-in connection rectangular multi-contact rack/panel connector of this series is about 20% smaller in length than that of the QR/P4 Series with the same number of contacts.
- Approved by UL, CSA, and TÜV.
- Two pairs of power supply contacts on both sides are located at the guide pin reinforcing section of the housing to realize compact design.
- Blade contacts ensure dealing with tolerance of the coupling length, and connectors are mounted to racks or panels with stepped screws for easy mating and unmating.
- Compact design with guide pins integrated with insulator.

#### Applications

PPC, communications equipment, Automatic vending machines, Measurement equipment, Industrial equipment, Distribution boards

#### Specifications

| Item                             | Requirements   |
|----------------------------------|--|
| No. of Positions                 | 8-12-20  |
| Current rating (A)               | 2-3  |
| Contact Plating                  | Gold   |
| Operating Temperature Range (°C) | -10 to 60  |
| Insulator                        | Polycarbonate (UL94V-0, Color: Black)                            |
| Applicable Cable (mm)            | Conductor:AWG#20 to 24,AWG#24 to 28                              |
| Industry Standard                | UL,CSA,TUV   |
| Remarks                          | Automatic crimp machine, crimp tool, applicator, extraction tool |