

# 13.0 Pitch 3500 SERIES CONNECTOR

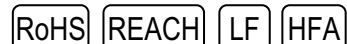

13.0 mm Pitch Wire-to-Board, Wire-to-Wire Connector



## 3500S Plug Housing ( Pitch 13.0mm )

### Specifications

- ◇ Current rating: 1A AC,DC (AWG 24)
- ◇ Voltage Range: 3000V AC,DC
- ◇ Withstand Voltage: 5000V AC/Minute
- ◇ Contact Resistance: 10 mΩ Max. before environment test
- ◇ Insulation Resistance: 1000 MΩ Min.
- ◇ Temperature Range: -40 °C to 105 °C

### Reference

- ◇ Mates with 3502P Pitch 13.0 Header
- ◇ Use with 3503T011R Crimp Terminal
- ◇ Certifications: UL, CSA, TUV

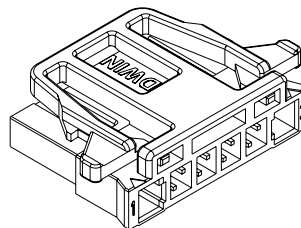

P/N : 3500S0200 -SA

※ Material : Nylon 66 94V-0, Natural (White)

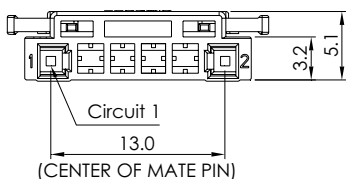
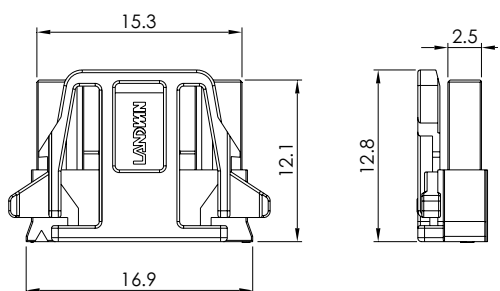

## 3503T01 Crimp Terminal

### Reference

- ◇ Mates with 3500S Plug Housing

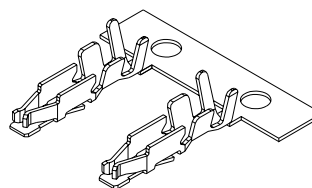
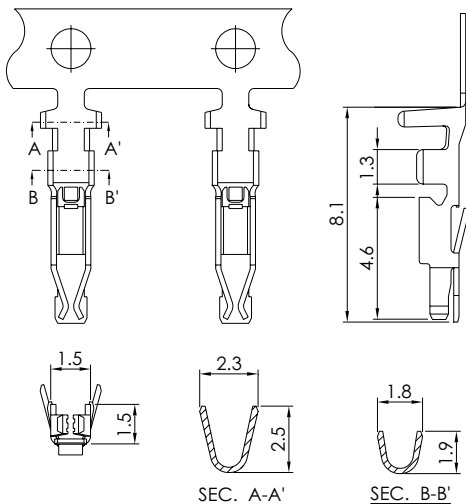

### Ordering Information

Part Number	Applicable Wire		Q'ty / Reel
	AWG #	Insulation O.D. mm	
3503T011R	24 - 28	1.6 Max.	12,000

### Material

Part	Material
3503T011R	Phosphor Bronze, Tin-Plated

※ Halogen-Free Product

# 13.0 Pitch 3500 SERIES CONNECTOR



13.0 mm Pitch Wire-to-Board Connector



**3502P DIP / SMT Right-Angle Header**  
( Pitch 13.0mm )

■ Specifications

- ◇ Current rating: 1A AC,DC (AWG 24)
- ◇ Voltage Range: 3000V AC,DC
- ◇ Withstand Voltage: 5000V AC/Minute
- ◇ Contact Resistance: 10 mΩ Max. before environment test
- ◇ Insulation Resistance: 1000 MΩ Min.
- ◇ Temperature Range: -40°C to 105°C
- ◇ Applicable PC Board Thickness: 1.6 mm

■ Reference

- ◇ Mates with 3500S Pitch 13.0 Series Housing
- ◇ Certifications: UL, CSA, TUV

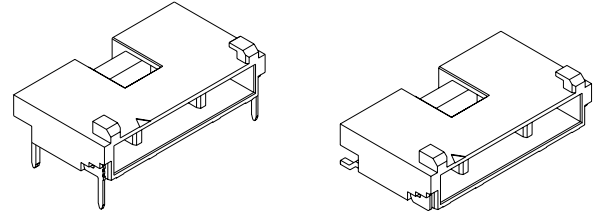

P/N : 3502P0200T -E

P/N : 3502P0200T -B

※ Material :

Base : High HDT Nylon 94V-0, Ivory Color  
Contact : Brass, 0.5mm Square Contact Matte Tin-plated  
Peg : Brass, Matte Tin-Plated

※ Material :

Base : High HDT Nylon 94V-0, Ivory color  
Contact : Brass, 0.5mm Square Contact, Matte Tin-plated  
Peg : Brass, Matte Tin-Plated

※ Mates with 3500S0200 -SA

※ SMT Embossed Tape Packing

※ Available P/N of Halogen-Free replacement: 3502P0200T-ENH

※ Mates with 3500S0200 -SA

※ Available P/N of Halogen-Free replacement: 3502P0200T-BNH

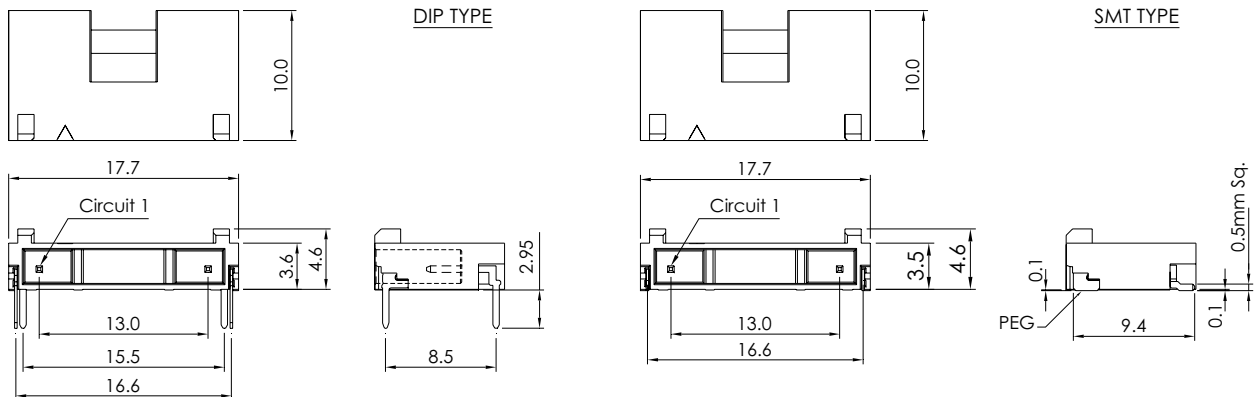

P.C. Board Layout / Assembly Layout

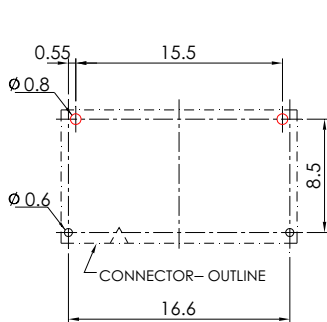

P. C. BOARD LAYOUT  
DIP Application (TYPE-E)

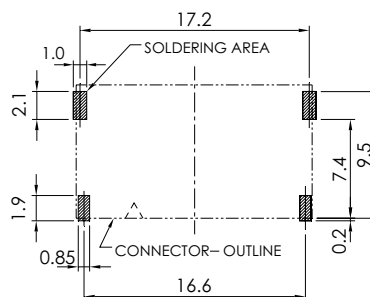

P. C. BOARD LAYOUT  
SMT Application (TYPE-B)

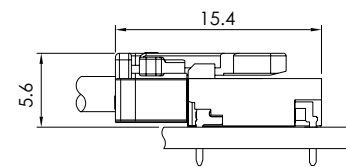

ASSEMBLY (DIP)

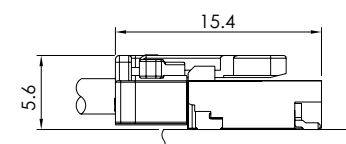

ASSEMBLY (SMT)

# 13.0 Pitch 3500 SERIES CONNECTOR



13.0 mm Pitch Wire-to-Wire Connector



## 3500M Pin Contact Housing Pitch 13.0mm

### Specifications

- ◇ Current rating: 1A AC,DC (AWG 24)
- ◇ Voltage Range: 3000V AC,DC
- ◇ Withstand Voltage: 5000V AC/Minute
- ◇ Contact Resistance: 10 mΩ Max. before environment test
- ◇ Insulation Resistance: 1000 MΩ Min.
- ◇ Temperature Range: -40 °C to 105 °C

### Reference

- ◇ Mates with 3500S0200-SA Housing
- ◇ Used with 3503T021R terminal

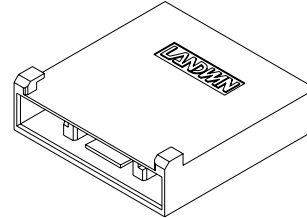

P/N : 3500M02A0

※ Material : Nylon 66 94V-0, Natural (White)

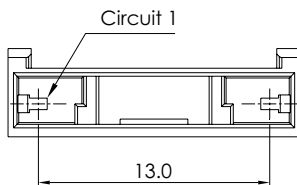
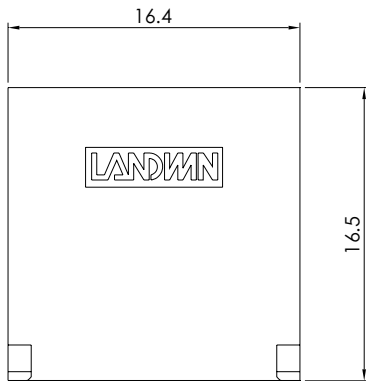

### Assembly Layout

