

3.5 Pitch 3500 SERIES CONNECTOR



3.5 mm Pitch Wire-to-Board, Wire to Wire Connector



3500S Plug Housing

Specifications

- ◇ Current rating: 1A AC,DC (AWG 24)
- ◇ Voltage Range: 1400V AC,DC
- ◇ Withstand Voltage: 3800V AC/Minute
- ◇ Contact Resistance: 10 mΩ Max. before environment test
- ◇ Insulation Resistance: 1000 MΩ Min.
- ◇ Temperature Range: -25°C to 85°C
- ◇ Material: Nylon 66 94V-0, Natural (White) color

Reference

- ◇ Mates with 3502P Headers, 3500S0210 Housing
- ◇ Use with 3503T Terminal
- ◇ Certifications: UL, CSA, TUV

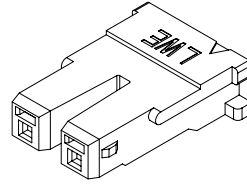

P/N : 3500S0200

※ Available P/N of Halogen-Free replacement:
3500S0200-SNH

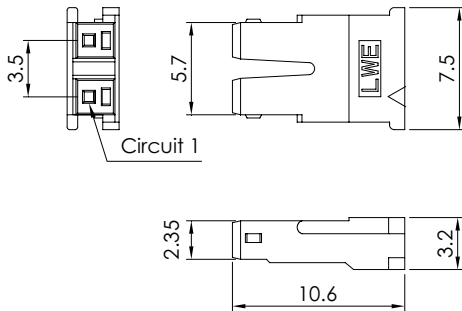

DIP-Type

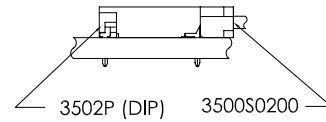

SMT-Type

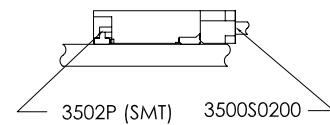

3500S Plug Housing Type-1

Specifications

- ◇ Current rating: 1A AC,DC (AWG 24)
- ◇ Voltage Range: 1400V AC,DC
- ◇ Withstand Voltage: 3800V AC/Minute
- ◇ Contact Resistance: 10 mΩ Max.
- ◇ Insulation Resistance: 1000 MΩ Min.
- ◇ Temperature Range: -25°C to 85°C
- ◇ Material: Nylon 66 94V-0, Natural (White) Color

Reference

- ◇ Mates with 3502P Headers, 3500S0210-1 Housing
- ◇ Use with 3503T Terminal

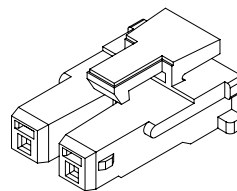

P/N : 3500S0200 -1

※ Available P/N of Halogen-Free replacement:
3500S0200-1NH

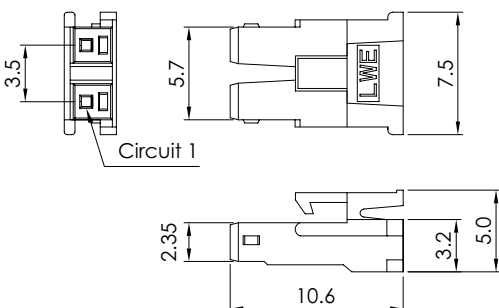

DIP-Type

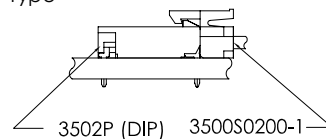

SMT-Type

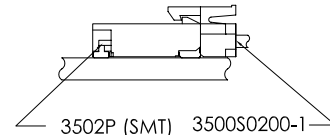

3.5 Pitch 3500 SERIES CONNECTOR



3.5 mm Pitch Wire-to-Board Connector



3502P DIP / SMT Right-Angle Header
Positive Lock Type

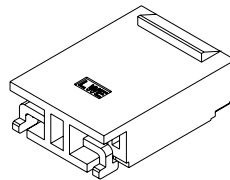
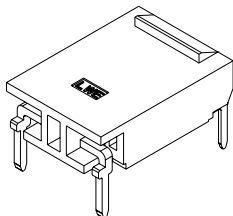

P/N : 3502P0250T

P/N : 3502P0240T

※ Material:
Base : High HDT Nylon 94V-0, Ivory color
Contact : Brass, Tin-plated
Peg : Brass, Tin-Plated

※ Material:
Base : High HDT Nylon 94V-0, Ivory color
Contact : Brass, Matte Tin-plated
Peg : Brass, Matte Tin-Plated

※ Mates with 3500S0200-1 Housing

※ Mates with 3500S0200-1 Housing

※ Available P/N of Halogen-Free replacement:
3502P0400T-S0-NH

※ Available P/N of Halogen-Free replacement:
3502P0240T-SNH

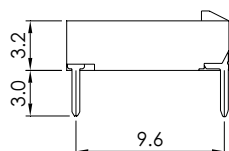
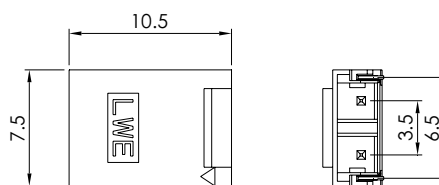
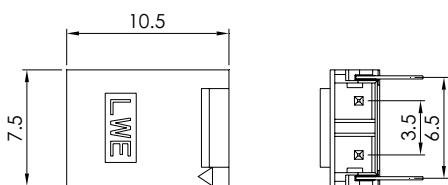

DIP Header

SMT Header

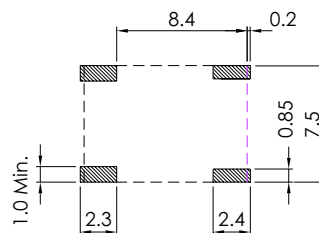
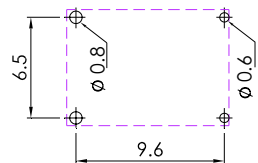

P.C. Board Layout

P.C. Board Layout

Assembly Layout

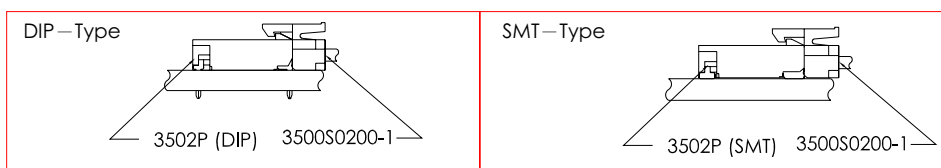

3.5 Pitch 3500 SERIES CONNECTOR



3.5 mm Pitch Wire-to-Board Connector (TWO-IN-ONE)



3502P DIP/SMT Right-Angle Header Friction Lock Type

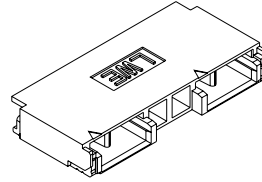
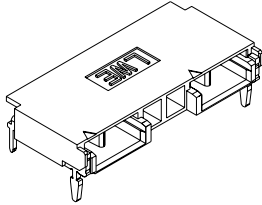

P/N : 3502P0400T

P/N : 3502P04S0T

- ※ Material:
 - Base : High HDT Nylon 94V-0, Ivory color
 - Contact : Brass, Matte Tin-plated
 - Peg : Brass, Matte Tin-Plated

- ※ Material:
 - Base : High HDT Nylon 94V-0, Ivory color
 - Contact : Brass, Matte Tin-plated
 - Peg : Brass, Matte Tin-Plated

※ Mates with 3500S0200 Housing

※ Mates with 3500S0200 Housing

※ Available P/N of Halogen-Free replacement:
3502P0400T-SNH

※ Available P/N of Halogen-Free replacement:
3502P04S0T-SNH

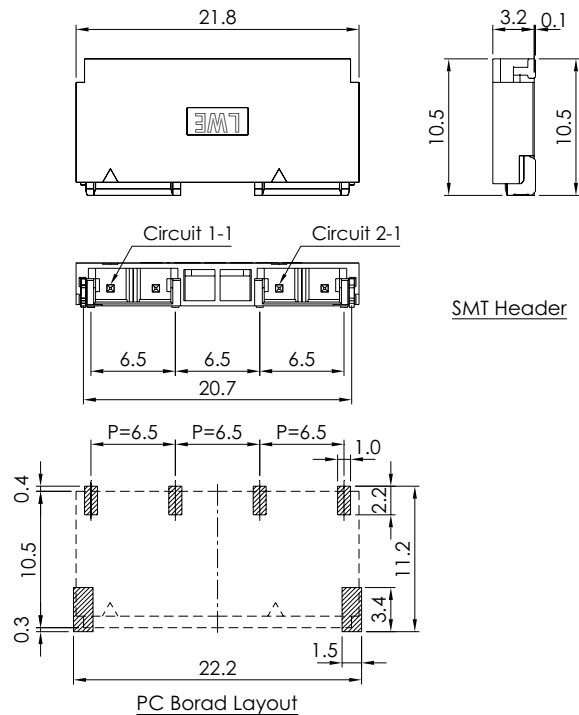
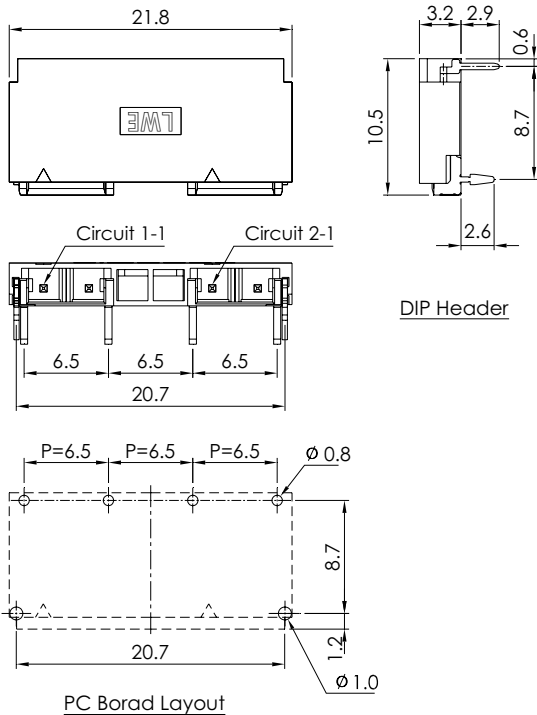

Assembly Layout

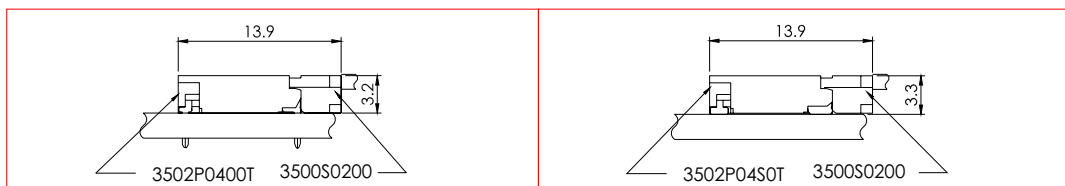

3.5 Pitch 3500 SERIES CONNECTOR



3.5 mm Pitch Wire-to-Board Connector (TWO-IN-ONE)



3502P DIP/SMT Right-Angle Header Positive Lock Type

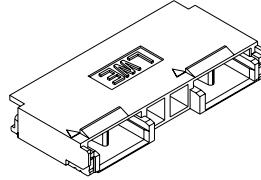
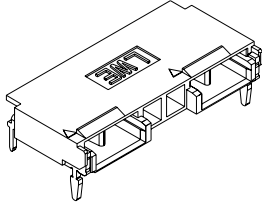

P/N : 3502P0400T-SD

P/N : 3502P04S0T-SD

- ※ Material:
 - Base : High HDT Nylon 94V-0, Ivory color
 - Contact : Brass, Matte Tin-plated
 - Peg : Brass, Matte Tin-Plated

- ※ Material:
 - Base : High HDT Nylon 94V-0, Ivory color
 - Contact : Brass, Matte Tin-plated
 - Peg : Brass, Matte Tin-Plated

※ Mates with 3500S0200-1 Housing

※ Mates with 3500S0200-1 Housing

※ Available P/N of Halogen-Free replacement:
3502P0400T-SDNH

※ Available P/N of Halogen-Free replacement:
3502P04S0T-SDNH

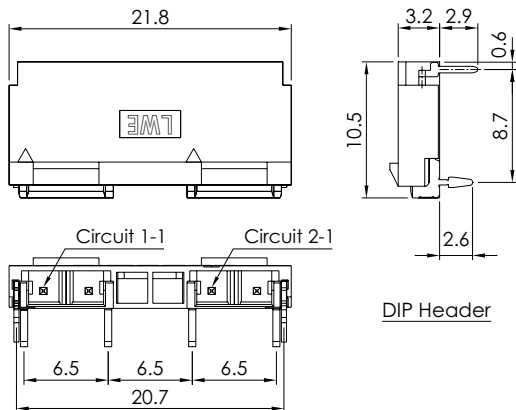

DIP Header

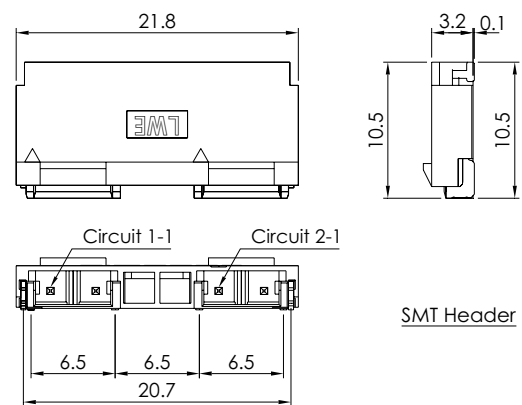

SMT Header

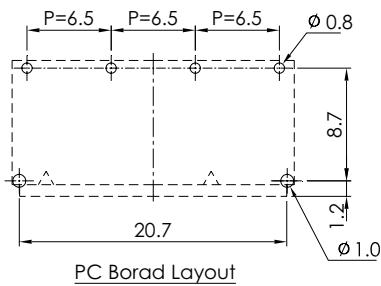

PC Board Layout

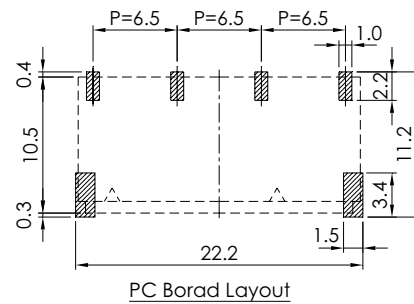

PC Board Layout

Assembly Layout

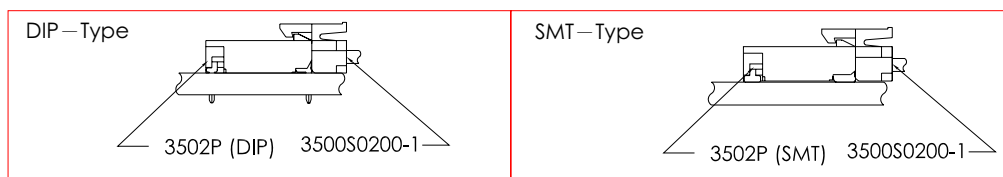

3.5 Pitch 3500 SERIES CONNECTOR



3.5 mm Pitch Wire-to-Wire Connector

RoHS REACH LF HFA

3500S Receptacle Housing (Type-1)

Specifications

- ◇ Current rating: 1A AC,DC (AWG 24)
- ◇ Voltage Range: 1400V AC,DC
- ◇ Withstand Voltage: 3800V AC/Minute
- ◇ Contact Resistance: 10 mΩ Max. before environment test
- ◇ Insulation Resistance: 1000 MΩ Min.
- ◇ Temperature Range: -25 °C to 85 °C

Reference

- ◇ Mates with 3500S0200 Housing
- ◇ Use with 3503T021R Terminal

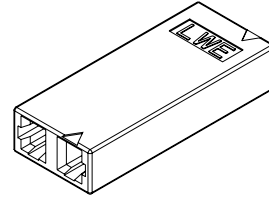

P/N : 3500S0210

※ Material : Nylon 66 94V-0 Natural (White)

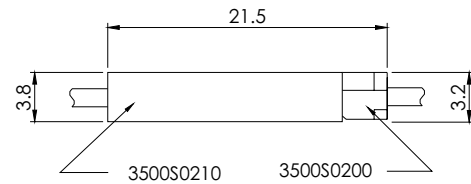
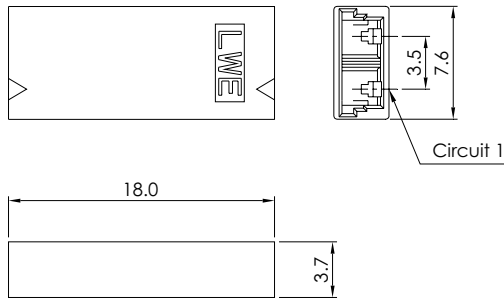

Assembly Layout

3500S Receptacle Housing With Lock (Type-1)

Specifications

- ◇ Current rating: 1A AC,DC (AWG 24)
- ◇ Voltage Range: 1400V AC,DC
- ◇ Withstand Voltage: 3800V AC/Minute
- ◇ Contact Resistance: 10 mΩ Max.
- ◇ Insulation Resistance: 1000 MΩ Min.
- ◇ Temperature Range: -25 °C to 85 °C

Reference

- ◇ Mates with 3500S0200-1 Housing
- ◇ Use with 3503T021R Terminal

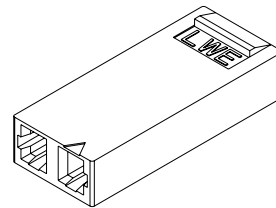

P/N : 3500S0210-1

※ Material: Nylon 66 94V-0 Natural (White)

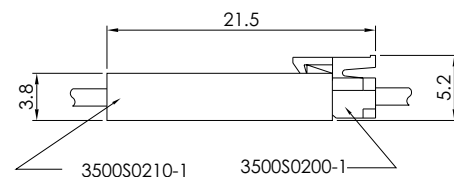
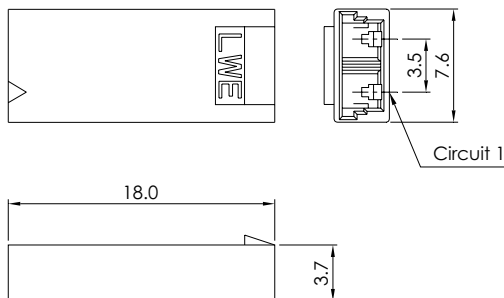

Assembly Layout

3.5 Pitch 3500 SERIES CONNECTOR



3.5 mm Pitch Wire-to-Wire Connector



3503T01 Crimp Terminal

■ Reference

◇ Mates with 3500S0200, 3500S0200-1 Plug Housing

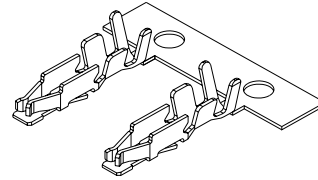
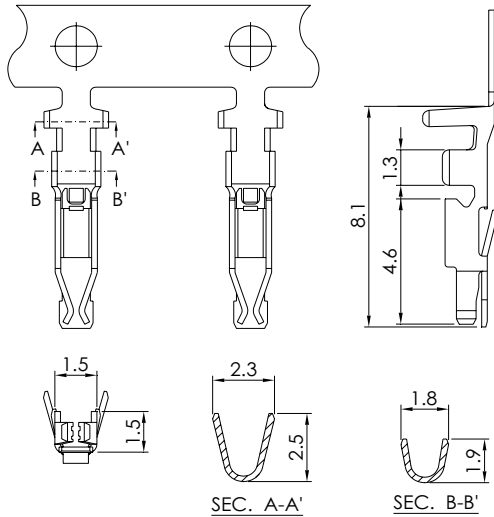

Ordering Information

Part Number	Applicable Wire		Q'ty / Reel
	AWG #	Insulation O.D. mm	
3503T011R	24 - 28	1.6 Max.	12,000

Material

Part	Material
3503T011R	Phosphor Bronze, Tin-Plated

※ Halogen-Free Product

3503T02 Crimp Pin Contact

■ Reference

◇ Mates with 3500S0210, 3500S0210-1 Receptacle Housing

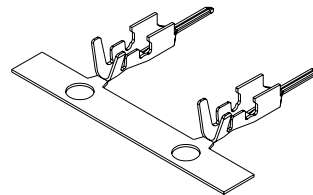
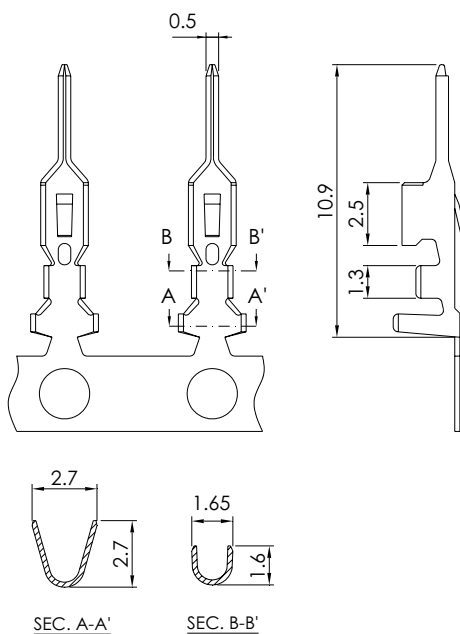

Ordering Information

Part Number	Applicable Wire		Q'ty / Reel
	AWG #	Insulation O.D. mm	
3503T021R	24 - 28	1.8 Max.	10,000

Material

Part	Material
3503T021R	Phosphor Bronze, Tin-Plated

※ Halogen-Free Product